

OCT 0 9 1990

TOSHIBA

INTEGRATED CIRCUIT

TECHNICAL DATA

TC8830F

C²MOS VOICE RECORDING/REPRODUCING LSI

TC8830F

11 July, 1986

Revision 1 June, 1987

[1] GENERAL

The TC8830F is a single chip C MOS LSI for voice recording and reproducing LSI using the ADM (Adaptive Delta Modulation) system. Voice recording and reproducing can be made by externally connecting S-RAM for voice data recording.

• Features

- (1) S-RAM is used to record voice data.
Maximum 4 units of 64 Kbit or 256 Kbit S-RAM can be connected directly.
- (2) Recording and reproducing of up to 16 phrases are possible (at the manual control). At the CPU control, number of phrases can be further increased.
- (3) Direct access to phrases (instantaneous reproducing of phrase heads) is possible.
- (4) CPU control type and manual control type are selectable.
- (5) 4 kinds of bit rates (32 Kbps, 16 Kbps, 11 Kbps, 8 Kbps) are selectable.
- (6) A microphone is connectable directly as the microphone amplifier has been built in.
- (7) Built-in band-pass filter for cutting unnecessary band of synthesized voice.
- (8) Standby function making voice data reproducing possible.
- (9) Built-in oscillation circuit for ceramic vibrator.
- (10) 5V single power supply operation.

[2] EXAMPLE OF VOICE RECORDING/REPRODUCING DEVICE LSI SYSTEM CONFIGURATION

2.1 Example of manual control system configuration

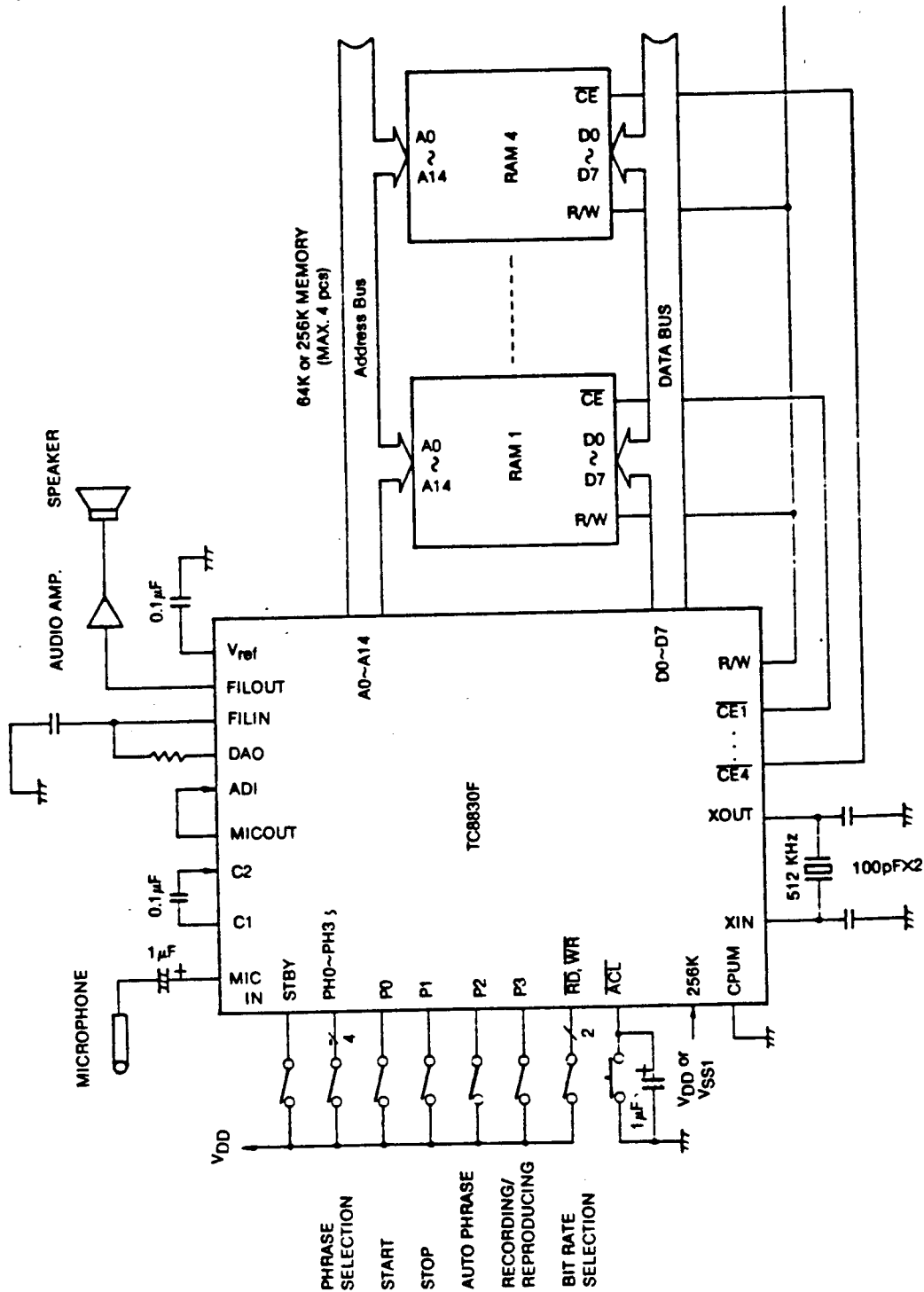

2.2 Example of CPU control system configuration

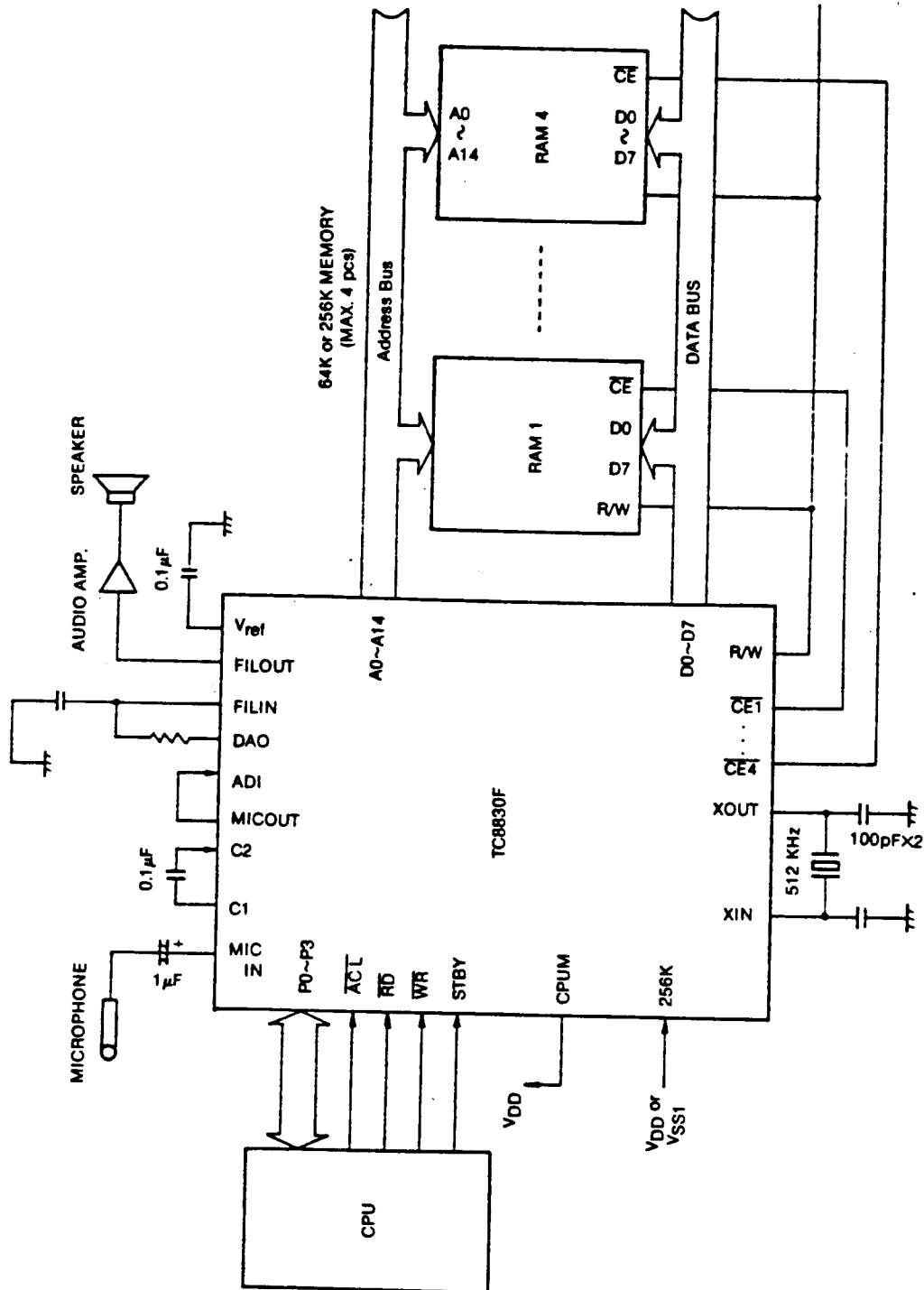

[3] BLOCK DIAGRAM

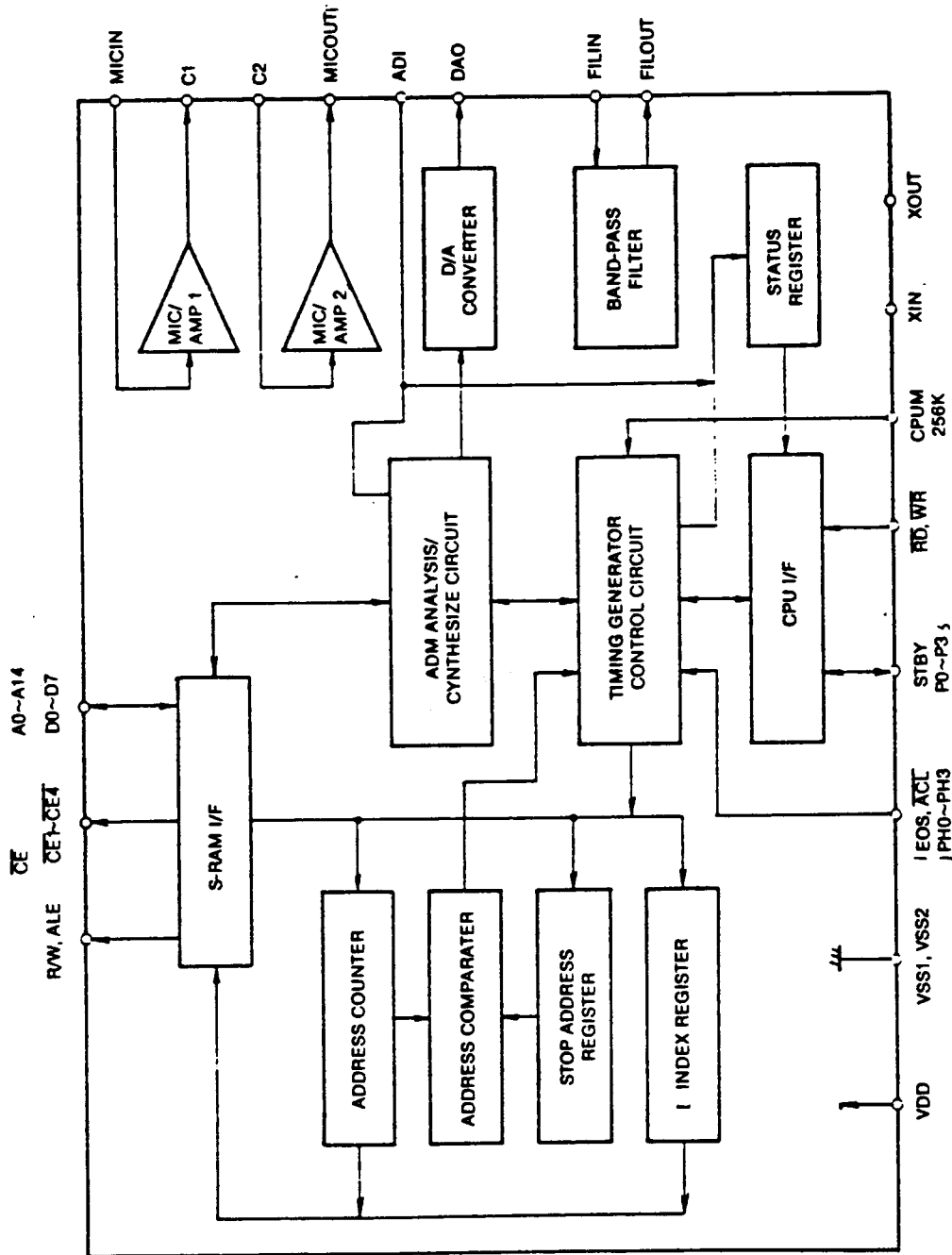

3.1 Block diagram

| | |
|-----------------------|---|
| Address counter | The 20-bit counter to show external S-RAM address. Address value is increased by one per 8 samplings during the recording and reproducing operations. At the CPU control, a value can be set by command and further, that value can also be read out. |
| Stop address register | The 20-bit register to show address to stop the recording operation and reproducing operation. |
| Address comparator | Detects matching of the address counter and the stop address register. When detected matching, directs stop of the address counter. |
| Index register | Shows address of the index area on S-RAM in the label index mode. |
| Status register | The 4-bit register showing the internal status. When RT pin is set to LOW level at time of the CPU control, contents of this register are output to P0 ~ P3 pins. |
| CPU I/F | The interface circuit with external CPU or peripheral device I/O ports. Further, this circuit contains the chattering preventive circuit which becomes valid only in the manual mode. |
| S-RAM I/F | The interface circuit for externally connecting S-RAM. |
| Microphone Amp 1 | The microphone amplifier for directly connecting. |
| Microphone Amp 2 | A microphone. Output from the microphone amplifier defects around analog reference voltage (V_{ref}). |
| Band-pass filter | The band-pass filter to cut off unnecessary bands at reproducing. This filter consists of a primary high-pass filter and a secondary low-pass filter. |

[4] SPECIFICATION

| | |
|---|--|
| Voice analyzing/ synthesizing system | ADM (Adaptive Delta Modulation) system |
| Bit rate | 32 Kbps/16 Kbps/11 Kbps/8 Kbps |
| Number of maximum | In manual control 16 |
| | In manual control (Auto phrase function) 63 |
| | Direct mode in CPU control No res- triction |
| | Lable index mode in CPU control 63 |
| Operating frequency | 512 kHz (Typ.) |

[5] OPERATIONAL DESCRIPTION

When composing a voice recording and reproducing system using the TC8830F, there are two controls; the manual control which perform the control by directly connecting switches, etc. and the CPU control which performs the control by connecting external CPU or I/O ports of peripheral device to the TC8830F.

5.1 Manual control (CPUM pin="L")

The input pins for controlling the TC8830F are 14 pins of P0, P1, P2, P3, \overline{WR} , \overline{RD} , PH0, PH1, PH2, PH3, STBY, CPUM, 256K and \overline{ACL} .

When the CPUM pin out of these pins is set at "L" level, the TC8830F is set at the manual control.

5.1.1 Selection of phrases

16 phrases from phrase No. 0 to phrase No. 15 can be recorded by setting 4 input pins of PH0 ~ PH3. Likewise, the direct access (instantaneous reproducing of phrase heads) reproducing of 16 phrases from phrase No. 0 to phrase No. 15 by setting 4 input pins of PH0 ~ PH3. In addition, recording and reproducing up to 63 phrases are possible by using the auto-phrase function which is described later.

Selection of Phrases

| Phrase No. | Pin name | MSB PH3 | PH2 | PH1 | LSB PH0 |
|------------|----------|------------|-----|-----|------------|
| No. 0 | | 0 | 0 | 0 | 0 |
| No. 1 | | 0 | 0 | 0 | 1 |
| No. 2 | | 0 | 0 | 1 | 0 |
| ↓ | | ↓ | ↓ | ↓ | ↓ |
| No.15 | | 1 | 1 | 1 | 1 |

1="H" level
0="L" level

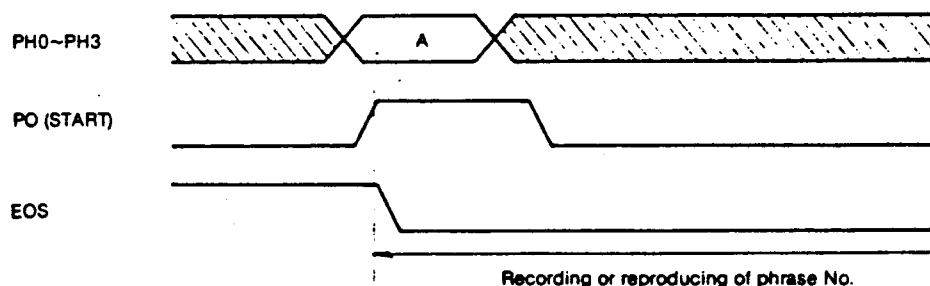

[Note] When recording multiples number of phrases, set up phrase Nos. in order of smaller numbers as shown in example 1.

Example 1 ○ No.0 → No.1 → No.2 → No.3
 ○ No.2 → No.4 → No.15

Example 2 × No.15 → No.14 → No.13 → No.12
 × No.0 → No.4 → No.1

Further, when reproducing recorded phrases, desired phrases can be reproducing as many as desired in any order.

5.1.2 Auto-phrase function **P2 (AUTO) pin="H"**

Phrase No. can be increased automatically by one at a time when P2 pin is set to "H" level. At this time, initial value of phrase No. is decided by phrase No. shown by PH0 ~ PH3 pin when P2 pin is changed from "L" level to "H" level.

Recording Mode **P3(REC)="H"**

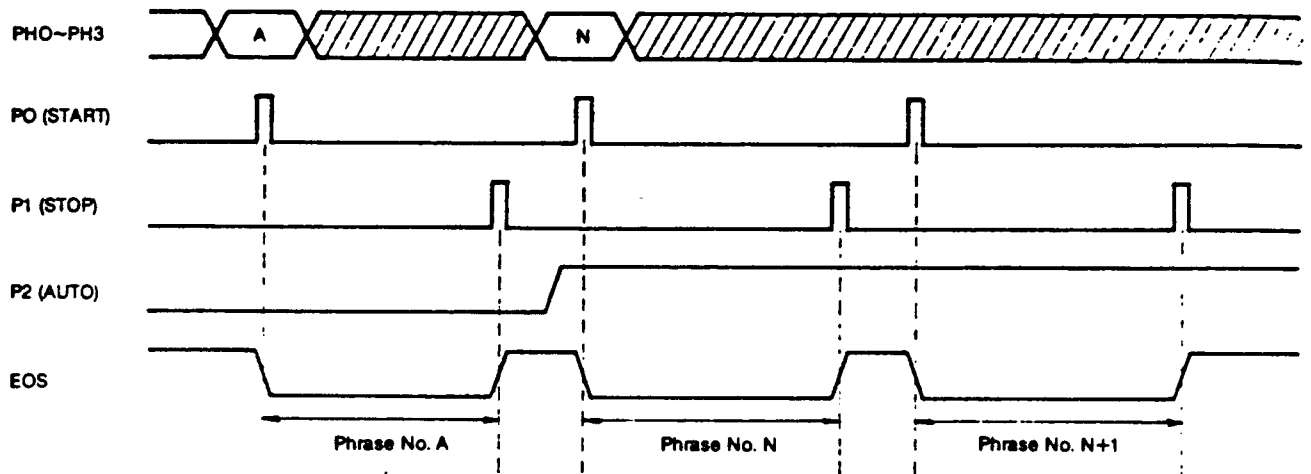

Reproducing Mode **P3(REC)="L"**

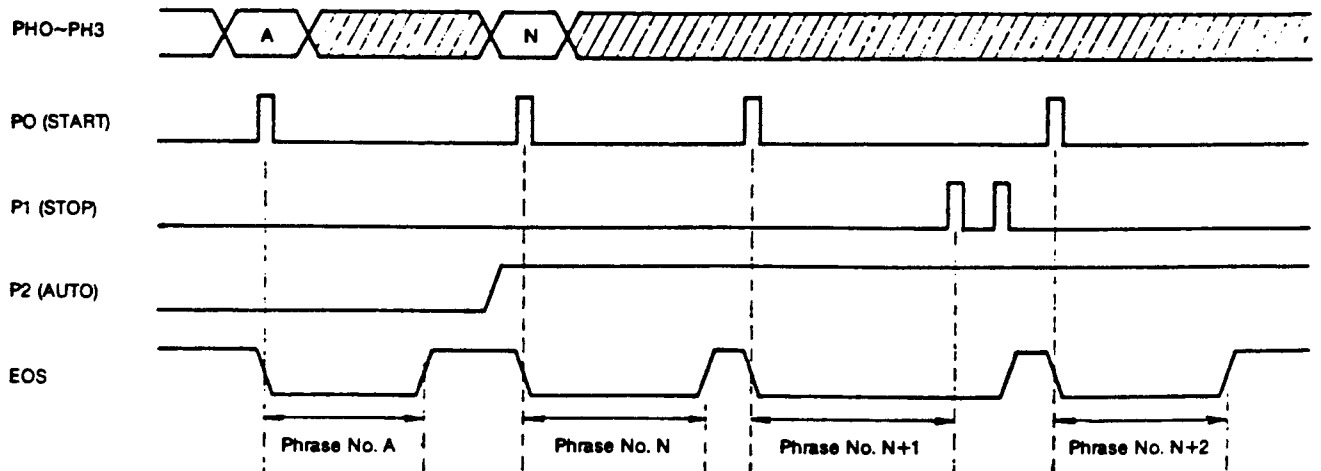

- [NOTE] 1: When P2 pin is at "H" level, setup of PH0 ~ PH3 pin has no meaning.
- 2: Setup of phrases by the auto-phrase function is valid from phrase No. 0 to phrase No. 62. If phrases in excess of phrase No. 62 are recorded, erroneous data are recorded on RAM. Therefore, be careful not to record phrases by exceeding phrase No. 62.
- 3: Direct access reproducing (instantaneous reproducing of phrase heads) is not possible for phrases from phrase No. 16 through phrase No. 62.

5.1.3 Selection of bit rates

Bit rate is selectable from 4 kinds; 32Kbps, 16Kbps, 11Kbps and 8Kbps by setting up the \overline{WR} and \overline{RD} pins.

Selection of bit rate

| Bit rate | Division Ratio from original oscillation | \overline{WR} | \overline{RD} |
|----------|--|-----------------|-----------------|
| 8K bps | 64 | 0 | 0 |
| 11K | 48 | 0 | 1 |
| 16K | 32 | 1 | 0 |
| 32K | 16 | 1 | 1 |

0 ... "L" level

1 ... "H" level

[NOTE] The \overline{WR} and \overline{RD} pins should be set up before starting the recording/reproducing, and under the state of recording/reproducing operations, they should be kept in HOLD data.

5.1.4 Status change at manual control

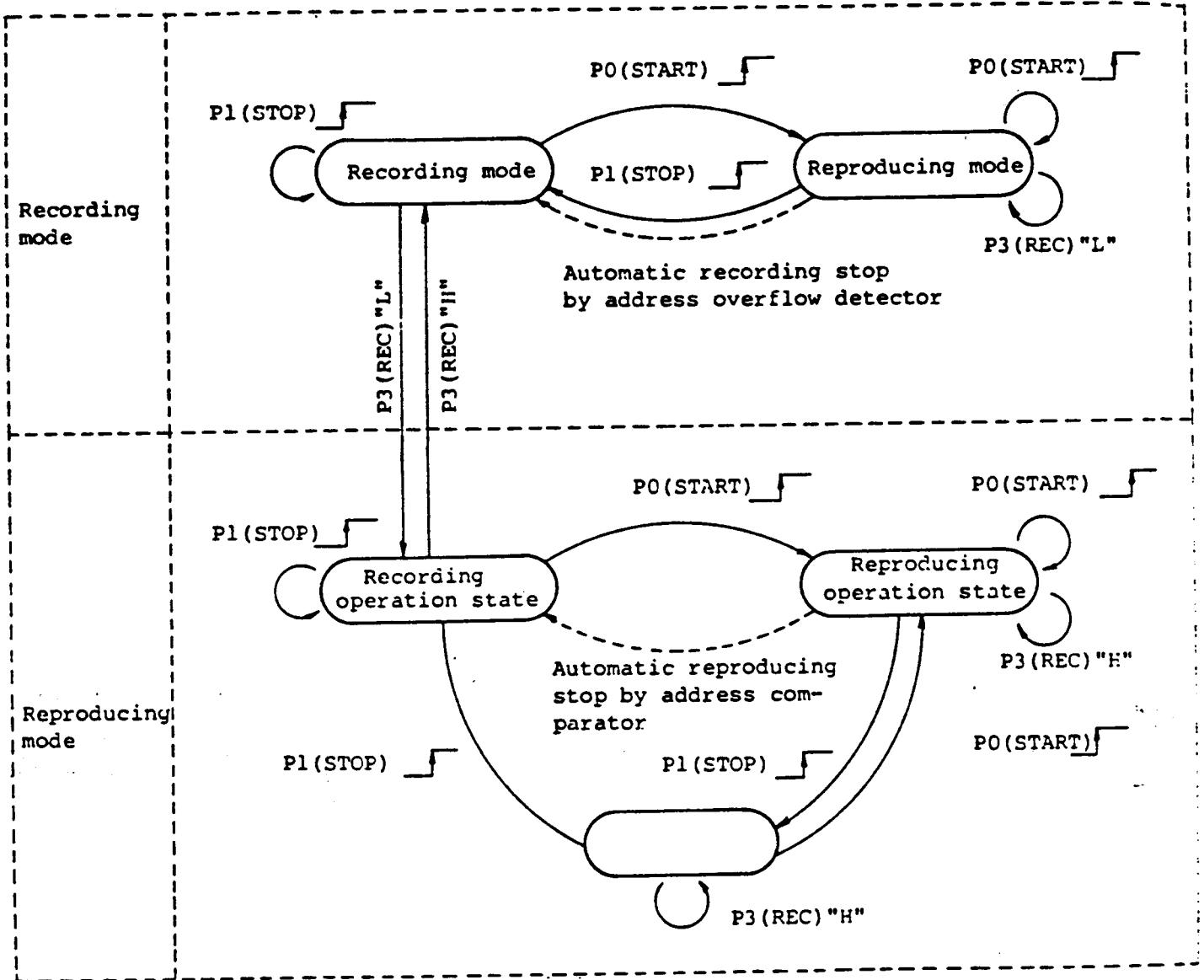

5.1.5 Setting up recording mode, reproducing mode

The recording and reproducing are changed over by the P3 pin.

The TC8830F is set in the recording mode when the P3 pin is at "H" level and in the reproducing mode at "L" level.

5.1.6 Recording **P3(REC) pin="H"**

When the P0 pin is set to "H" level in the recording mode, the recording starts. During the recording state, the TC8830F writes voice analysis data onto external RAM. Addresses at this time are controlled by the internal address counter.

To halt the recording, set the P1 pin to "H" level. This ends the recording of one phrase. When multiple phrases are to be recorded, refer to 5.1.2 "Selection of Phrases".

Further, when the address counter reaches the final address of RAM in the recording state, the recording is stopped automatically by the address overflow detector which is built in the TC8830F. Though the final address of RAM differs depending upon number of RAMs to be connected, the TC8830F copes with automatically.

P3(REC) = "H"

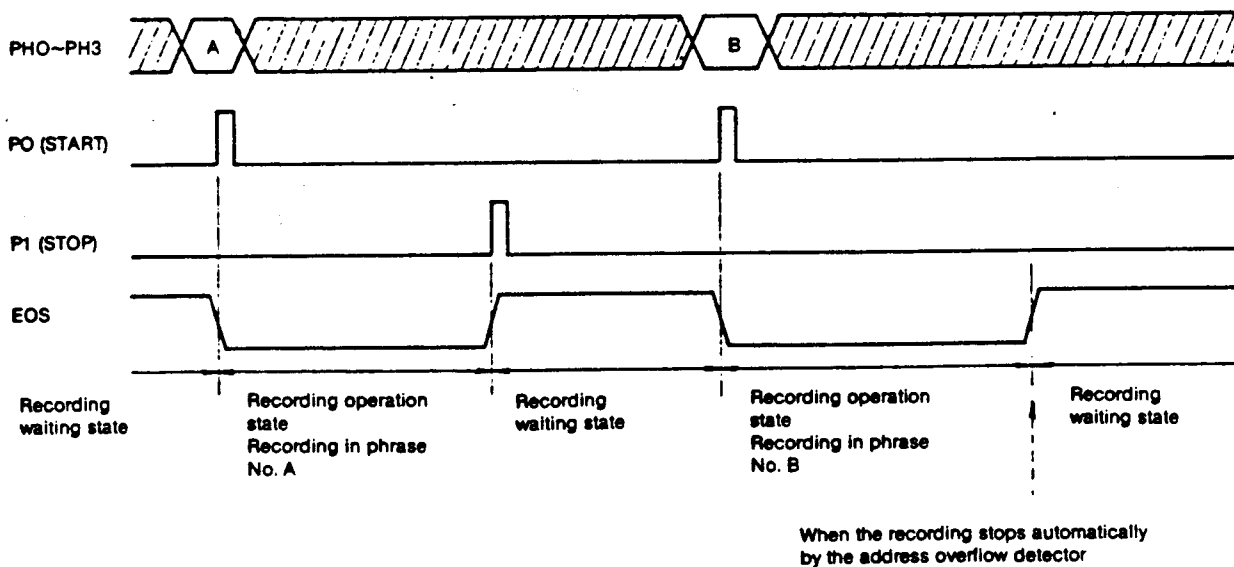

- [NOTE] • During the recording operation, input to the P0 pin is not accepted.
- When the address overflow detector detects the final address of RAM and stops the recording automatically, the recording operation cannot be started unless the TC8830F is initialized by the ACL input.

5.1.7 Reproducing **P3(REC) pin="L"**

When the P0 pin is changed over to "H" level from "L" level in the reproducing mode, the reproducing starts. Under the reproducing operation state, the TC8830F reads data, which were analyzed and recorded in the recording state, from external RAM, synthesizes and reproduces voices. When reproducing of one phrase ends, the TC8830F is places automatically in the reproducing waiting state for reproducing next phrase. Further, when selecting phrases to be reproduced, refer to "5.1.2 selection of phrases".

P3(REC)="L"

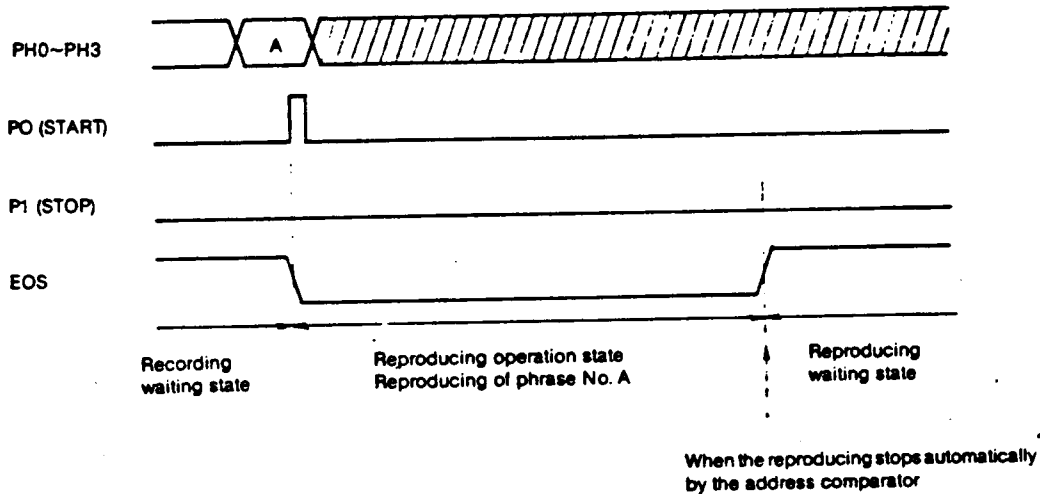

- [NOTE] • During the reproducing operation, input to the P0 pin is not accepted.
- When the recording operation and the reproducing operation starts, there is the following restriction between the P0 pin input and the P1 input.

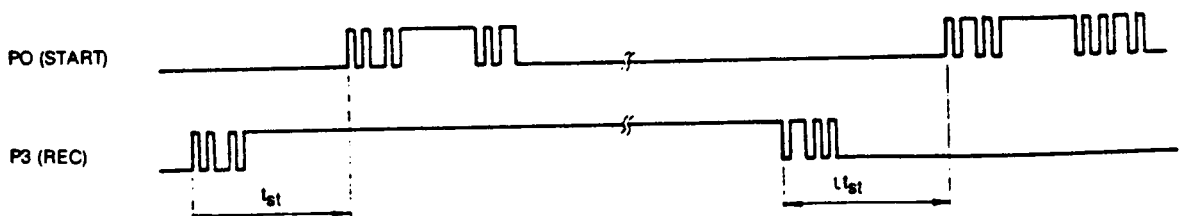

$t_{st} \geq 32 \text{ ms}$ (OSC=512kHz)

5.1.8 Pause function

In the reproducing mode it is possible to pause the reproducing during the reproducing operation by setting the P1 pin to "H" level. To reproduce the paused phrase continuously, set the P0 pin to "H" level. Further, if the P1 pin is once more set at "H" level in the pause state, the TC8830F is ready to accept the reproducing operation.

P3(REC) = "L"

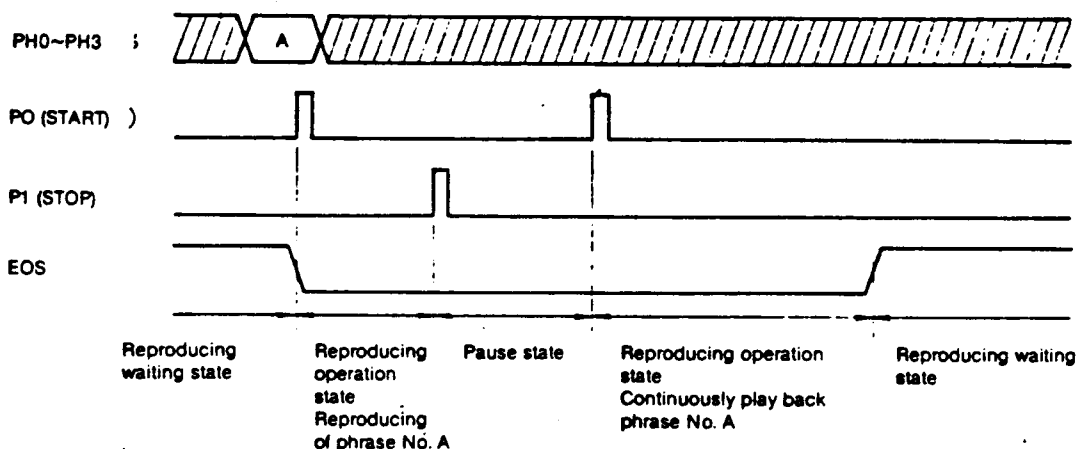

P3(REC) = "L"

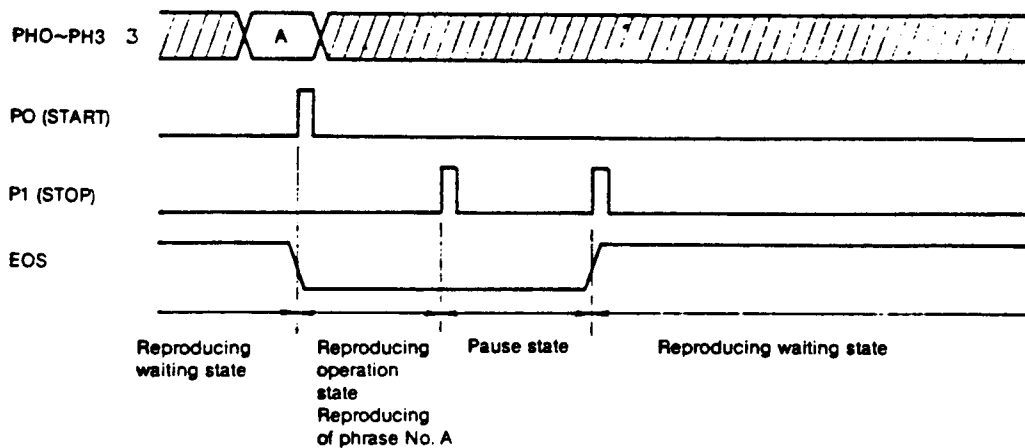

5.1.9 Recording/reproducing time

Recording/reproducing time is determined by type and quantity of RAMs to connected to the TC8830F and bit rate.

Recording/reproducing time

| External RAM | Recording/ reproducing time | Recording/reproducing time (sec) | | | |
|-----------------|-----------------------------------|----------------------------------|--------|--------|-------|
| | | Bit rate | | | |
| | | 32Kpbs | 16Kbps | 11Kbps | 8Kbps |
| 64K S-RAM | 1 pc | 2 | 4 | 6 | 8 |
| | 2 pcs | 4 | 8 | 12 | 16 |
| | 3 pcs | 6 | 12 | 18 | 24 |
| | 4 pcs | 8 | 16 | 24 | 32 |
| 256K S-RAM | 1 pc | 8 | 16 | 24 | 32 |
| | 2 pcs | 16 | 32 | 48 | 64 |
| | 3 pcs | 24 | 48 | 72 | 96 |
| | 4 pcs | 32 | 64 | 96 | 128 |

Maximum 4 units of 64K S-RAM of 256K S-RAM can be connected directly to the TC8830F. To connect 64K S-RAM, set the 256K pin at "L" level, and to connect 256K S-RAMs, fix the 256K pin at "H" level.

[NOTE] • In the recording operation and reproducing state, do not change the level of the 256K pin.

5.1.10 Chattering preventive circuit

To prevent the malfunction by chattering of switches connected to the P0 ~ P3 pins at the manual control, the chattering preventive circuit acts. The chattering preventive time is about 64ms ($f_{osc}=512kHz$).

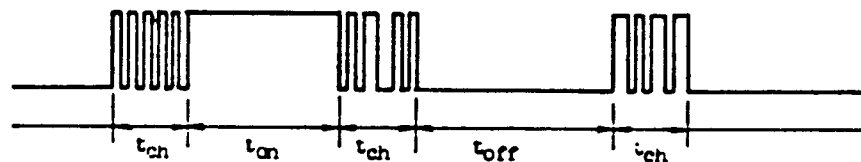

$t_{ch} \approx 64 \mu s$

$t_{on} \approx 64 ms$

$t_{off} \approx 64 ms$

($f_{osc} = 512 kHz$)

5.2 CPU control CPUM Pin="H"

When the CPUM pin is set at "H" level, the TC8830F is set at the CPU control, the operation of the TC8830F can be controlled by 11 kinds of commands using the P0 ~ P3, \overline{RD} and \overline{WR} pins. At this time, there are 2 kinds of control modes; the direct mode in which the start and end addresses of the address counter are set up by commands and the label index mode in which this address setting is performed by the TC8830F itself. Further, the built-in 4-bit status register allows to read the status of the TC8830F externally as required.

[NOTE] In the recording operation and reproducing state, do not change the level of the CPUM pin.

5.2.1 Explanation of commands

List of commands

| Command Name | Code | Functions |
|--------------|--------------|--|
| | PPPP 3210 | |
| NOP | 0001 | Sets up the reproducing mode. In addition, resets OVER bit of the status register. |
| START | 0010 | Starts the recording or reproducing operation in the direct mode from the address shown by the address counter. |
| STOP | 0010 | Stops the recording or reproducing operation. When this command is input to stop the recording started by the LABEL command, an operation to write a value of the address counter at time of the stop into the index area of RAM is performed. Further, when this command is input during the reproducing by the LABEL command, the pause state is resulted. When the START command is input successively, the TC8830F is placed in the reproducing state and input of the STOP command puts the TC8830F in the reproducing waiting state. |
| ADLD1 | 0100 | Sets address in the address counter by 5 nibble data following this command. After executing this command, the TC8830F is placed in the display waiting state. |
| CNDT | 0110 | Designates bitrate and validity/invalidity of the address overflow detector by 1 nibble data following this command. After executing this command, the TC8830F is placed in the display waiting state. |
| LABLE | 0111 | Designating phrase No. (0 ~ 62) by 2 nibble data following this command, starts the recording/reproducing. Input of this command in the recording mode writes contents of the address counter into the index area of RAM and then, starts the recording. In case of the reproducing mode, starts the reproducing after reading start address and stop address from the index area of RAM. |

| | | |
|------|------|---|
| ADRD | 1000 | Reads out contents of the address counter by 4 bits at a time in turn from the lower order by 5 successive read accesses. During this period, contents of the status register cannot be read. After executing this command, the TC8830F is ready to accept the reproducing operation. |
| REC | 1001 | Sets up the recording mode. |
| DTRD | 1010 | Reads data out of RAM by 2 successive read accesses. Readout address at this time is shown by the address counter. Further, this command does not change the address counter value. After executing this command, the TC8830F is ready to accept the reproducing operation. |
| DTWR | 1011 | Writes successive 2-nibble data onto RAM. Write address at this time is shown by the address counter. Further, this command does not change the address counter value. After executing this command, the TC8830F is ready to accept the reproducing operation. |

[NOTE] 1) Do not input other codes than those shown on the list of commands (0000, 1100, 1101, 1110 and 1111).

2) During the recording operation as well as the reproducing operation, do not input other commands than the stop command.

Command Data Format

| Command | 1st nibble pppp 3210 | 2nd nibble pppp 3210 | 3rd nibble pppp 3210 | 4th nibble pppp 3210 | 5th nibble pppp 3210 | 6th nibble pppp 3210 |
|---------|----------------------------|----------------------------|----------------------------|----------------------------|----------------------------|----------------------------|
| NOP | 0001 | — | — | — | — | — |
| START | 0010 | — | — | — | — | — |
| STOP | 0011 | — | — | — | — | — |
| ADLD1 | 0100 | A3 A2 A1 A0 | A7 A6 A5 A4 | A11 A10 A9 A8 | A15 A14 A13 A12 | A19 A18 A17 A16 |
| ADLD2 | 0101 | A3 A2 A1 A0 | A7 A6 A5 A4 | A11 A10 A9 A8 | A15 A14 A13 A12 | A19 A18 A17 A16 |
| CNDT | 0110 | 0 C BRJ BRO | — | — | — | — |
| LABEL | 0111 | PH3 PH2 PH1 PH0 | X X PH5 PH4 | — | — | — |
| ADRD | 1000 | A3 A2 A1 A0 | A7 A6 A5 A4 | A11 A10 A9 A8 | A15 A14 A13 A12 | A19 A18 A17 A16 |
| R1C | 1001 | — | — | — | — | — |
| DTRD | 1010 | D3 D2 D1 D0 | D7 D6 D5 D4 | — | — | — |
| DTWR | 1011 | D3 D2 D1 D0 | D7 D6 D5 D4 | — | — | — |

[NOTE] CNDT Command data

Bit rate setting

| Bit rate | P1 (BR1) | P0 (BR0) |
|----------|-------------|-------------|
| 8K bps | 0 | 0 |
| 11K bps | 0 | 1 |
| 16K bps | 1 | 0 |
| 32K bps | 1 | 1 |

Selection as to whether the address overflow detector performs the automatic recording stop by detecting the final address of RAM.

| Auto recording stop | P3 | P2 (C) |
|---------------------|----|-----------|
| Performs | 0 | 1 |
| Not performs | 0 | 0 |

(Does not set P3 at "1")

5.2.2 Change of internal blocks

| Internal block | ACL Input | Command input | | | | | | | | | | Instruction according to internal block | | |
|----------------------------|--------------|---------------|-------|------|-------|-------|------|-------|------|----------------|-------|---|--------------------|---------------------------|
| | | NOP | START | STOP | ADLD1 | ADLD2 | COND | LABEL | ADRD | REC | D/TRD | DTMR | Address comparator | Address overflow detector |
| Index register | R | | | | | | S | | | | | | *1 (+1) | |
| Address counter | R → S (100H) | | START | STOP | S | | S | START | | | | | STOP | *2 (STOP) |
| Stop address register | R | | | | | S | | | | | | | | |
| Address over-flow detector | ENABLE | | | | | | | | | ENABLE/DISABLE | | | | |
| Bit rate register | R (8K bps) | | | | | | | | | S | | | | |
| REC mode flag | R | R | | | R | R | R | R | R | R | R | R | | |
| EOS | | S | R | S | | | | | | | | | S | *2 (C) |
| | OVER flag | R | R | | | | | | | | | | | *2 (C) |
| Status register | | R | | | | | | | | | | | | |
| | EOS flag | R | S | R | | | | | | | | | R | *2 (R) |

S : SET
 R : RESET
 START: Address counter starts increment
 STOP: Address counter stops increment
 No entry: No change

*1. In the recording operation in the direct mode, address of the index area shown by the index register is increased by one phrase when the recording is stopped automatically by the address comparator.

*2. Becomes valid when the address overflow detector is enabled by the COND command.

[NOTE] Operation of address counter

| | |
|---------------------------------|---|
| <p>Setting of start address</p> | <p>Direct mode Start address is set up by the ADLD1 command. Label index mode ... In the recording mode, a value when the LABEL command is input, becomes the start address. In the reproducing mode, the start address recorded in the index area of RAM is automatically set up.</p> |
| <p>Start</p> | <p>Direct mode Started by the START command. Label index mode ... Started by the LABEL command.</p> |
| <p>Increment</p> | <p>Address is increased by one per 8 samplings.</p> |
| <p>Stop</p> | <p>Direct mode Stops automatically when the address comparator detected match of the stop address register with the address counter. Label index mode ... In the recording mode, stops when the STOP command is input. When the address comparator detected match of the stop address register with the address counter. Common to direct mode and label index mode When the address overflow detector detects RAM end in the recording mode, stops automatically.</p> |

5.2.3 Control in direct mode

The direct mode is a control mode to set start address and end address of the address counter by commands.

— Recording in direct mode —

(1) Set start address in the address counter by the ADLD1 command (Fig. 1).

(2) Set end address in the stop address register by the ADLD3 command (Fig. 2).

(3) Set the TC8830F in the recording mode by the REC command.

(4) Start the recording by the START command. The contents of the address counter is increased and voice analysis data is written in the data area of S-RAM (Fig. 3).

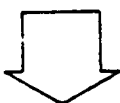

The address comparator detects match of the address counter value with the stop address register value and automatically stops the recording. The address counter value at this time is written in the index area of S-RAM (Fig. 4).

[NOTE] Set up start address and end address so that voice analysis data is not written in the index area.

Fig. 1

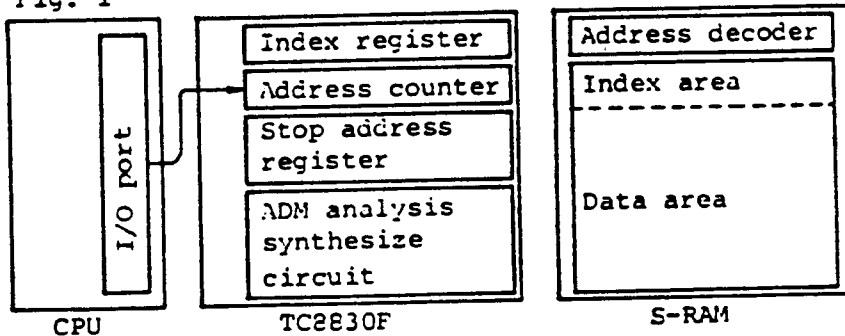

Fig. 2

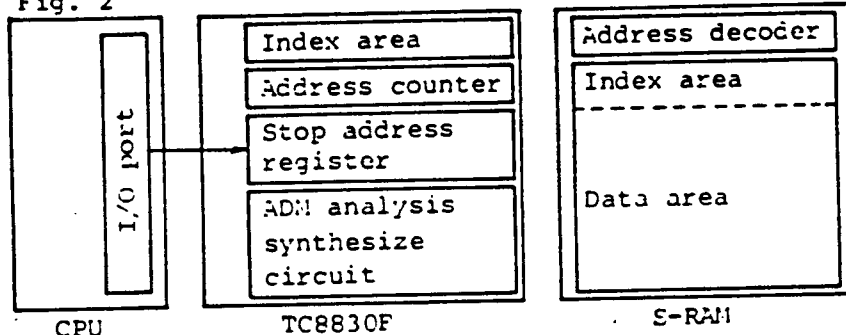

Fig. 3

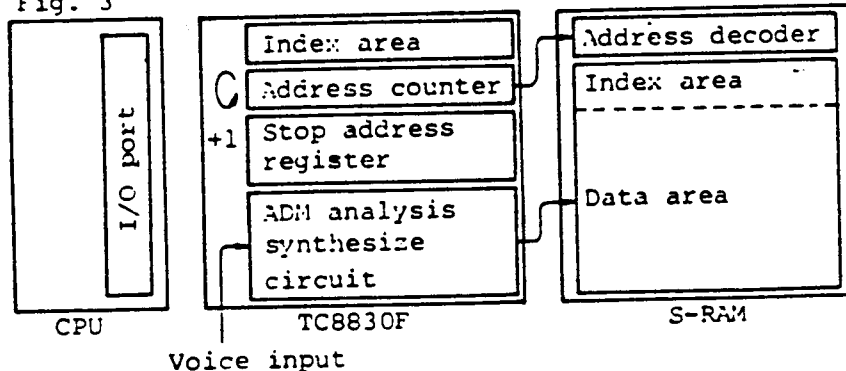
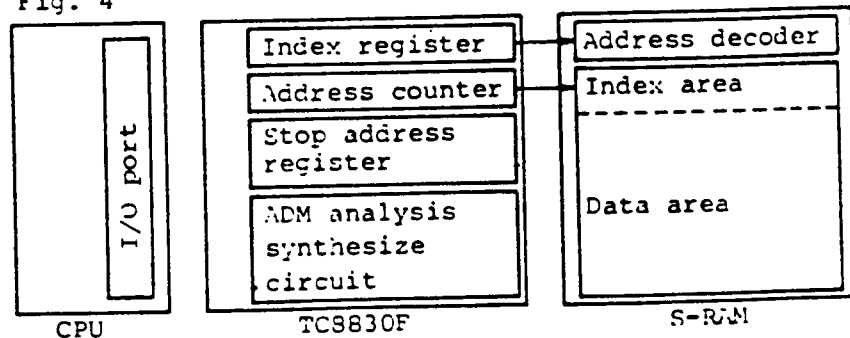

Fig. 4



— Reproducing in direct mode —

(1) Set start address in the address counter by the ADLD1 command (Fig. 1)

(2) Set end address in the stop address register by the ADLD2 command (Fig. 2)

(3) Start the reproducing by the START command. The contents of the address counter is increased and voice analysis data written in the data area of S-RAM is loaded. (Fig. 3)

Fig. 1

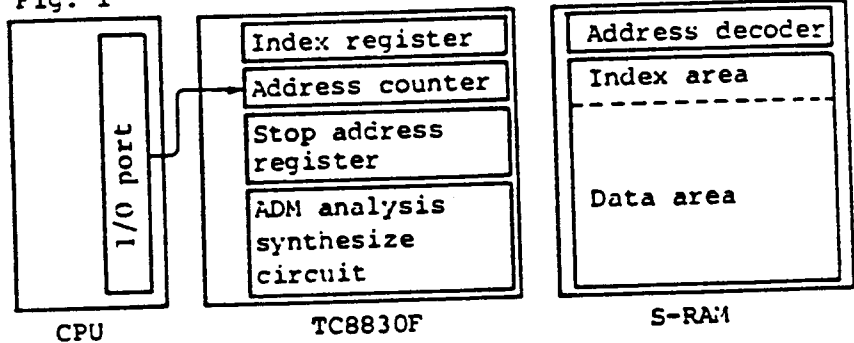

Fig. 2

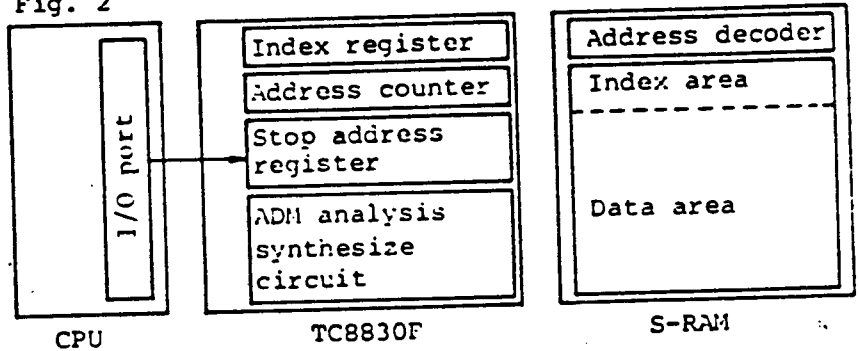
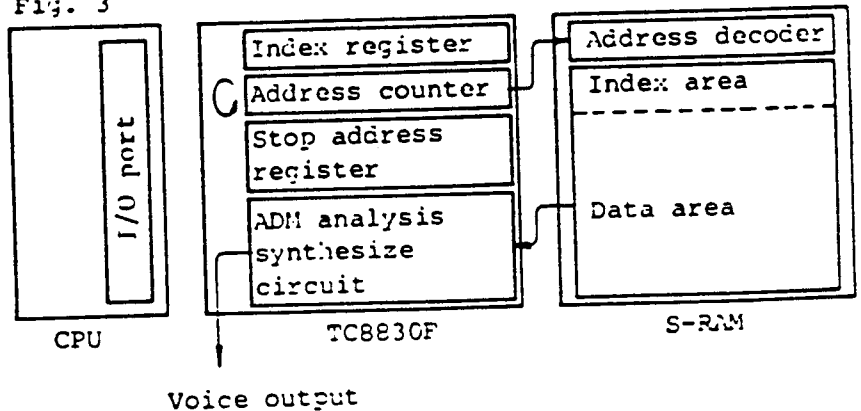

Fig. 3



The address comparator detects match of the address counter value with the stop address register value and automatically stops the reproducing.

Voice output

[NOTE]

(1) Behavior of the index register in the direct mode.

When the recording of one phrase ends in the direct mode (when the address comparator detected match of the address counter value and the stop address register value and automatically stopped the recording), the TC8830F writes the address counter value at that time into the index area of S-RAM. The write address at this time is controlled by the index register. The operations of the index register in the direct mode are described below.

- As a result of the initialization by the \overline{ACL} input, address in the index area corresponding to phrase No. is set.
- When the recording is stopped automatically by the address comparator during the recording operation in the direct mode, address of the index area shown by the index register is increased for one phrase.
- When the reproducing is made by the LABEL command, address of the index area corresponding to phrase No. designated at that time is set.

Refer to "Memory map of index area" described later for addresses of the index area, corresponding to respective phrase Nos. (From the above, it is necessary to pay attention not to write voice data into the index area.)

(2) Forced stop of recording in the direct mode

During the recording operation in the direct mode, it is possible to stop the recording by force. The address counter value when the recording was stopped by force can be read out by the ADRD command. Further, writing of end address into the index area is not performed at this time.

5.2.4 Control flowchart in the direct mode

(1) Recording

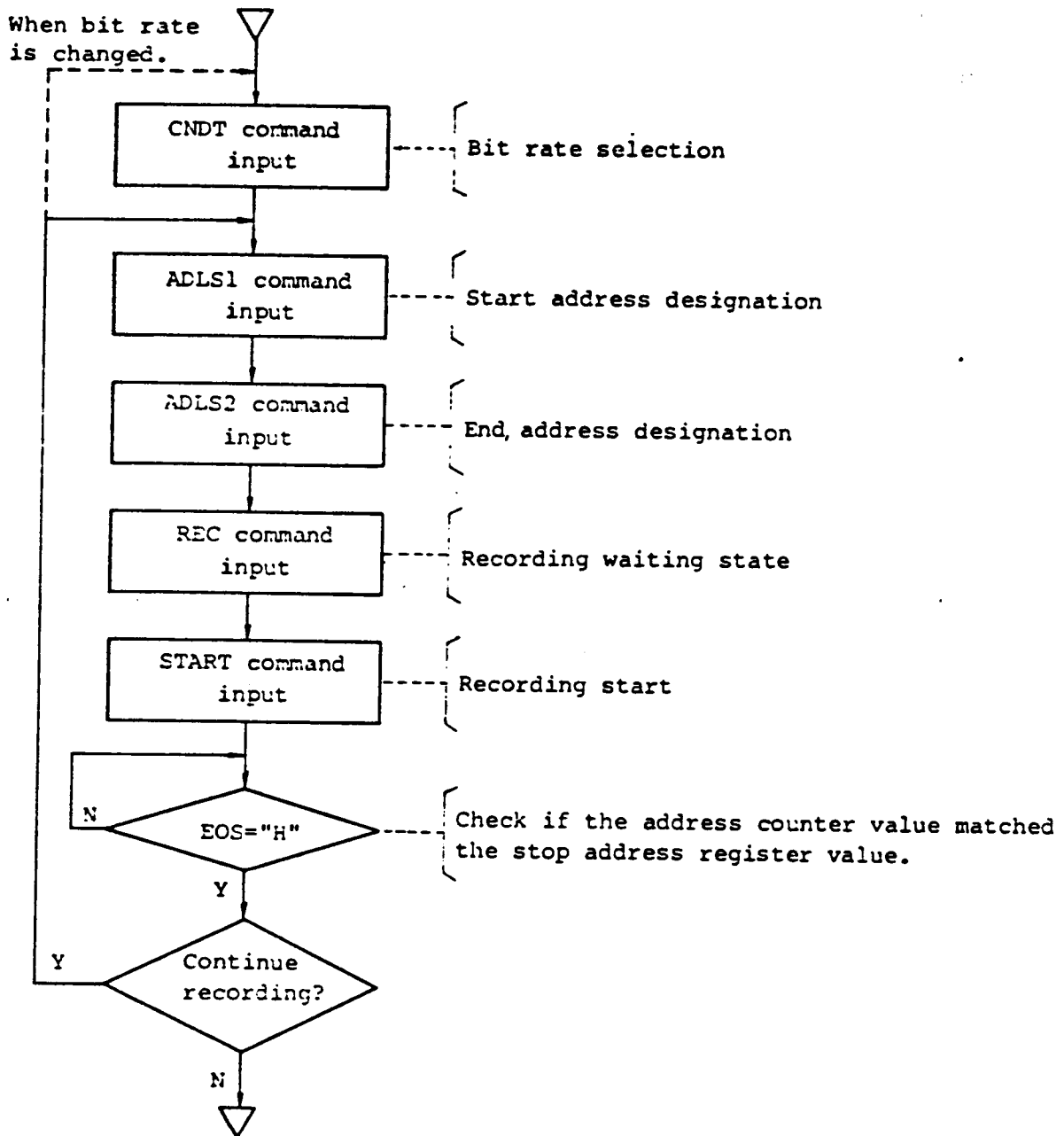

(2) Reproducing

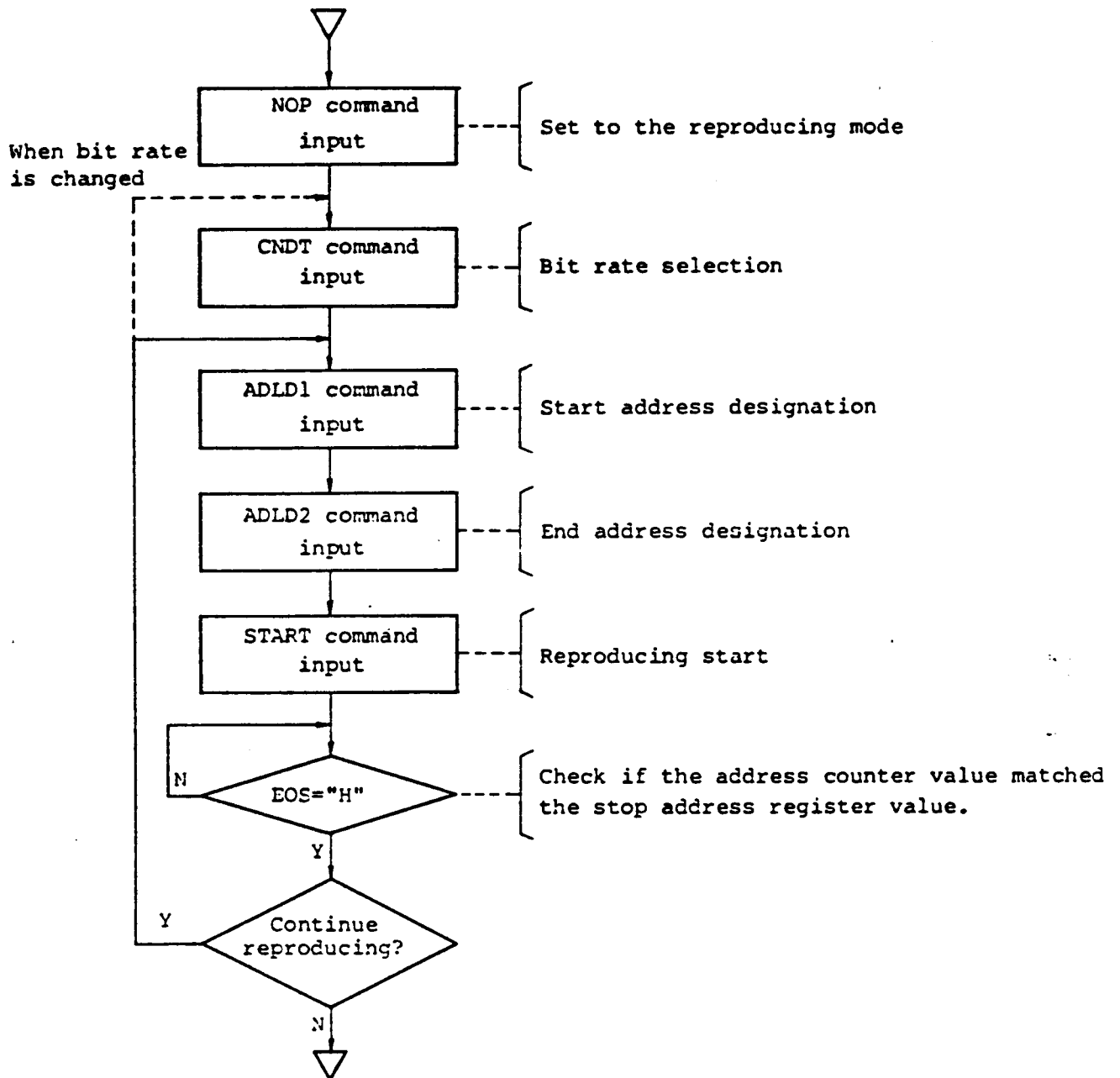

5.2.5 Control by label index mode

The label index mode is a control mode in which the TC8830F itself writes start address and end address of the address counter into the index area of S-RAM. It is therefore possible to perform the recording/reproducing from CPU (CPU peripheral I/O port) without designating start address and end address.

— Recording in Label Index Mode —

- (1) Set the TC8830F in the recording mode by the REC command.

- (2) Designating phrase No. by the LABEL command, instruct to start the recording.

Write start address in the index area of RAM corresponding to the designated phrase No. (Fig. 1).

The address counter is increased and voice analysis data is written in the data area of S-RAM (Fig. 2)



- (3) Instruct to stop the recording by the STOP command. The address counter stops and writes a value at the time into the index area of S-RAM corresponding to phrase No. (Fig. 3)

Fig. 1

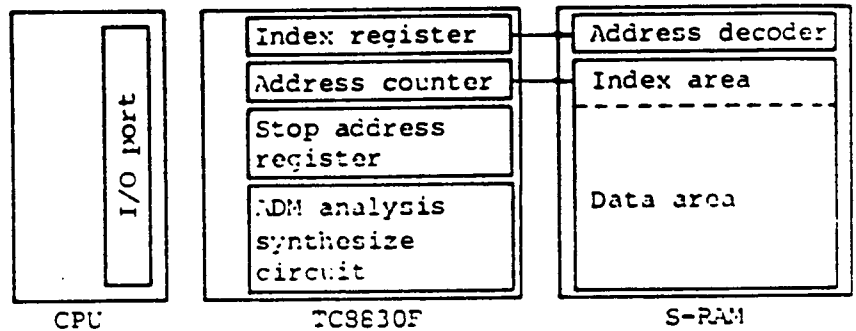

Fig. 2

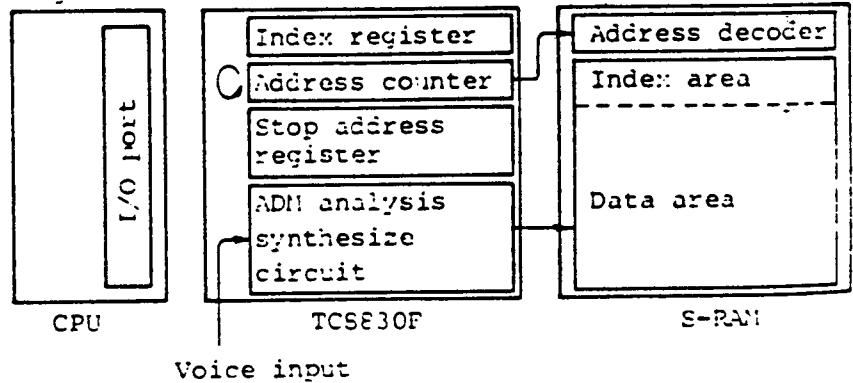
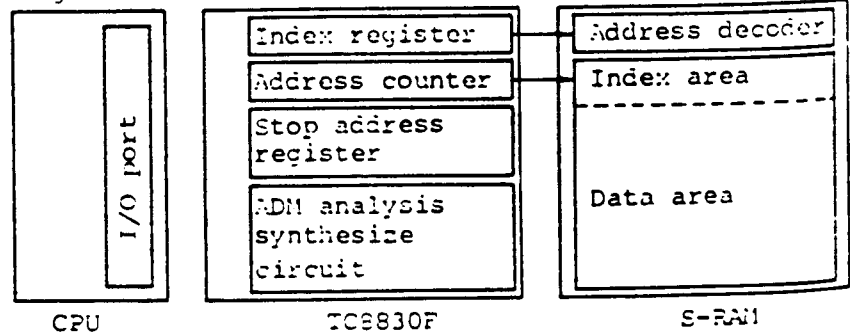

Fig. 3



— Reproducing in label index mode —

(1) Set the TC8830F in the reproducing mode by the NOP command.

(2) Designating phrase No. by the LABEL command, instruct to start the reproducing.

Load the start address from the index area of S-RAM corresponding to the designated phrase No. and set the address counter.

(Fig. 1)

Load the end address from the index area of S-RAM corresponding to the designated phrase No. and set the stop address register.

(Fig. 2)

The address counter is increased and the voice analysis data written in the data area of S-RAM is loaded. (Fig. 3)



The address comparator match of the address counter value with the stop address register value and automatically stops the reproducing.

Fig. 1

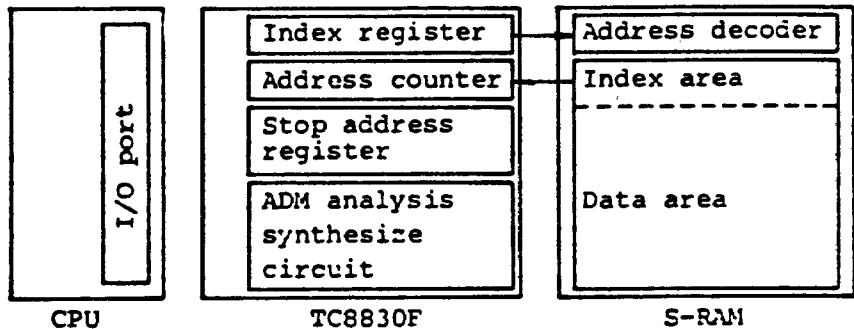

Fig. 2

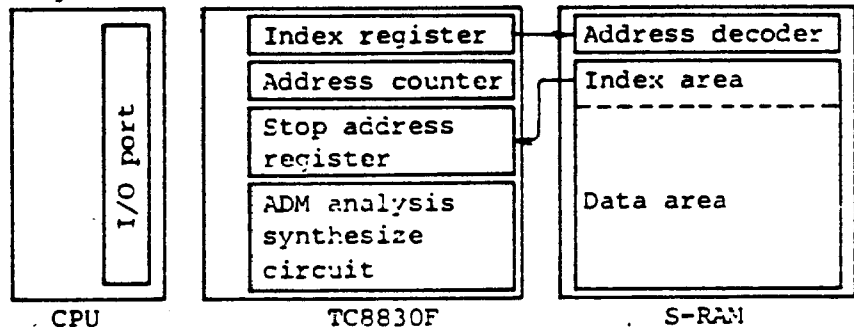
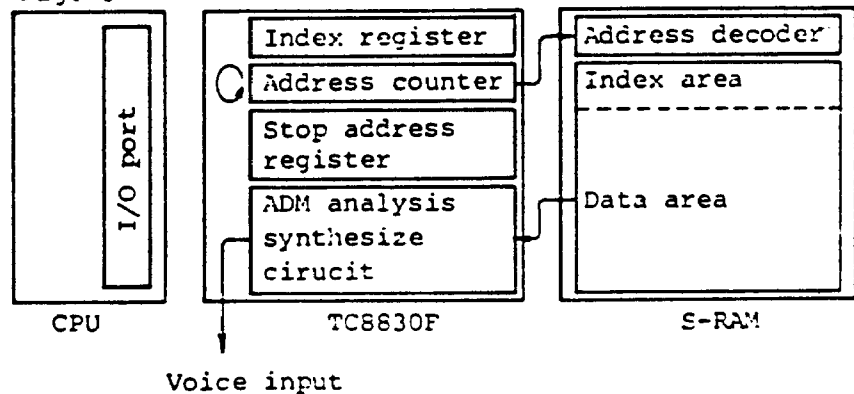
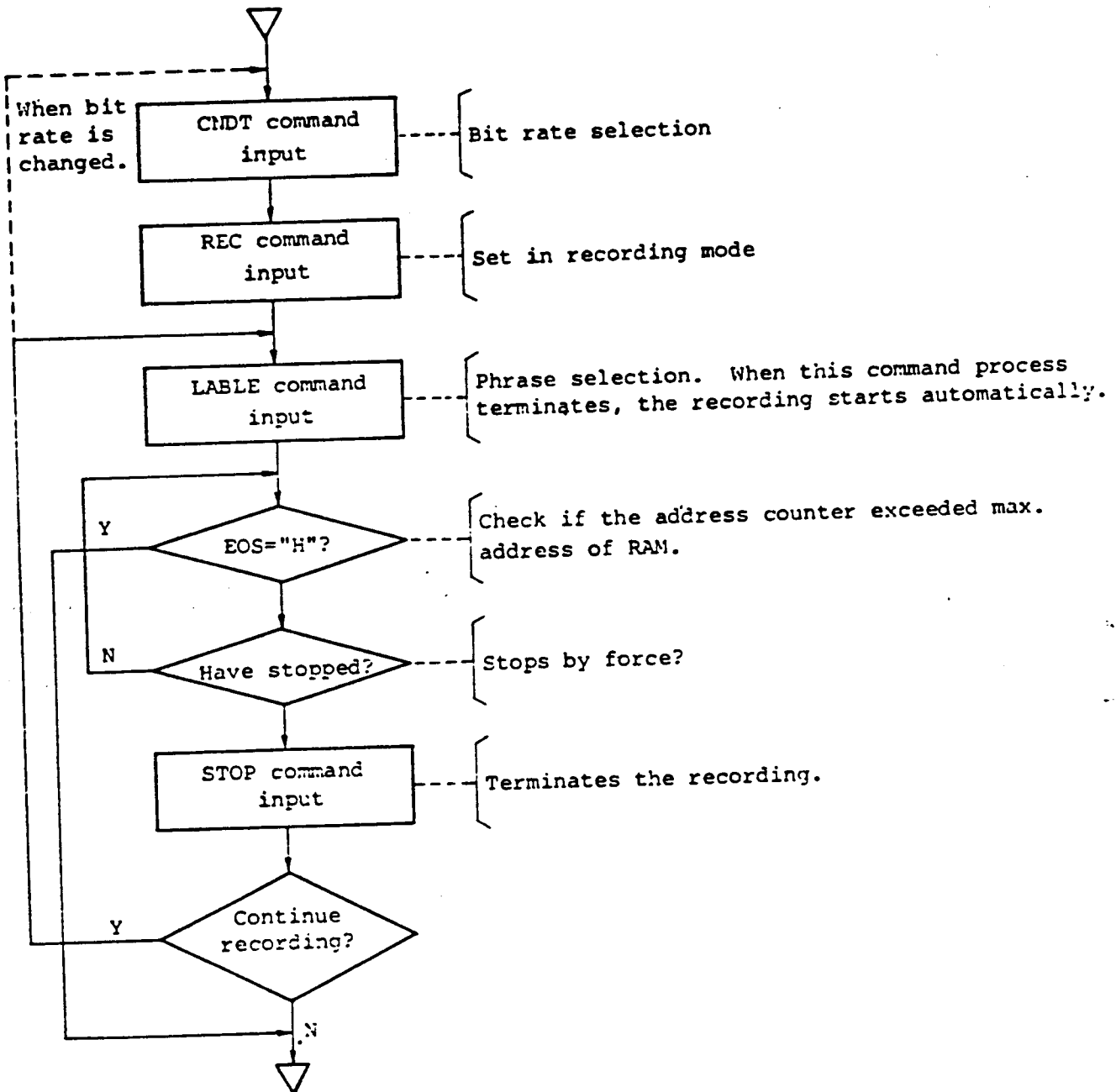

Fig. 3



5.2.6 Example of control flowchart in label index mode

(1) Recording



(2) Reproducing

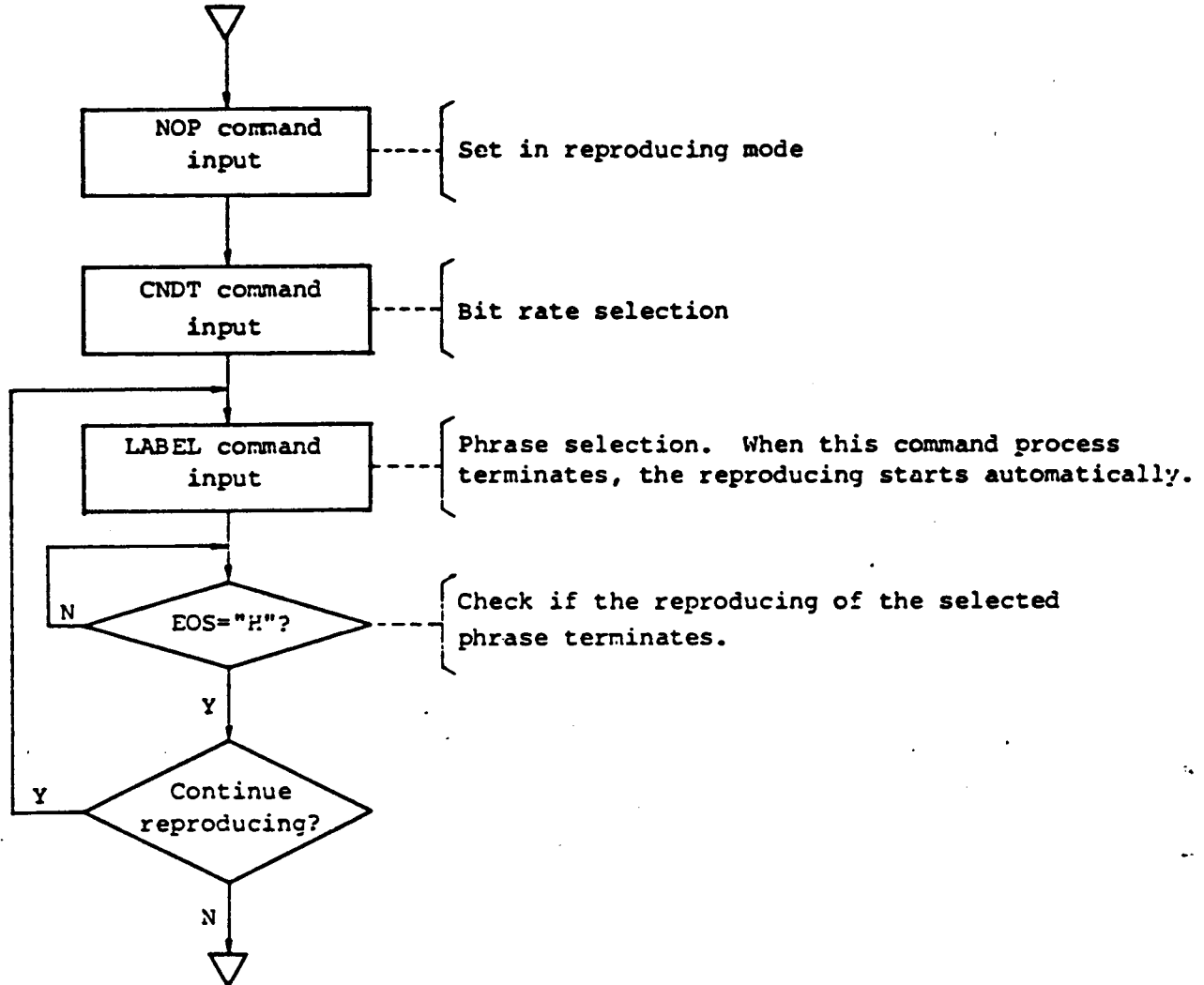

5.2.7 Status register

The status register is a 4-bit register showing the internal status of the TC8830F at time of CPU control. Data of the status register is output to the P0 ~ P3 pin by setting the \overline{RD} pin to "L" level.

| | | | | |
|----------|------|------|------|------------------|
| Pin name | P3 | P2 | P1 | P0 |
| Bit name | TRIG | OVER | BUSY | \overline{EOS} |

(1) TRIG

The TC8830F has a built-in ladder resistor type 10 bit D/A converter. What shows state of amplitude of analyzed voice in the recording operation is TRIG bit. Since this flag shows the third bit input data from the MBS of the D/A converter, TRIG bit will becomes "H" level only when input data for the D/A converter are as follows:

$$128/1024 \sim 256/1024, 384/1024 \sim 512/1024$$

$$640/1024 \sim 768/1024, 896/1024 \sim 1024/1024$$

Further, this flag is not kept held.

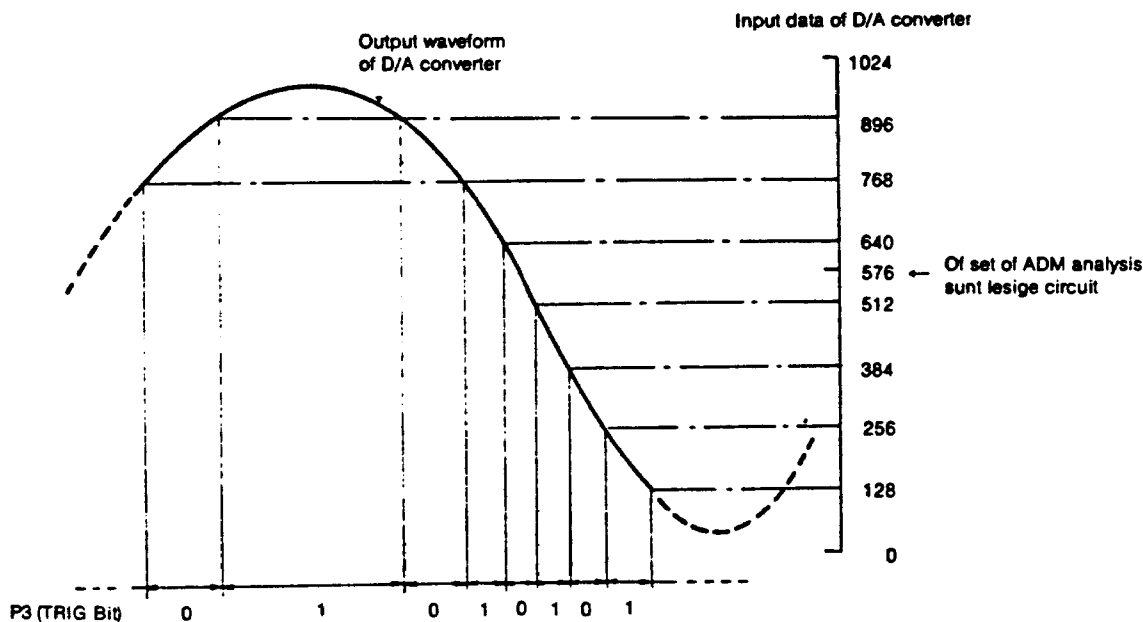

(2) OVER

This bit becomes "H" level when the recording is automatically stopped by detecting the final address of RAM. This flag is kept held until the TC8830F is reset by the NOP command.

(3) BUSY

This bit becomes "H" level during the command processing or the initialization. When this flag is kept held, do not input any command. When the ADLD1, ADLD2, CNDT, LABEL or command is input, until input of required data ends, this flag is not released.

(4) $\overline{\text{EOS}}$

This bit becomes "H" level during the recording operation and the reproducing operation. (Inversion output of the EOS pin.)

5.2.8 Command writing method

- After setting a command at the P0 ~ P3 pin, write the command by the \overline{WR} pulse.
- For the ADLD1, ADLD2, CNDT, LABEL and DTWR commands, write data following the command writing.
- For the ADRD and DTRD commands, read out data through the read access by the RD pulse following the command writing.
- Times required for processing commands are shown below. When inputting commands successively, input them at intervals of more than these command processing times.

| Command name | Command processing time |
|--|-------------------------|
| NOP, START, STOP, ADLD1 ADLD2, COND, REC, DTWR ADLD1, ADLD2, COND, { Data input of DTWR | 2T |
| LABEL, DTRD, ADRD { Data input of LABEL { Read access of DTRD and ADRD | 4T |

$T=31.3[\mu s](f_{osc}=512[kHz])$

(Example 1)

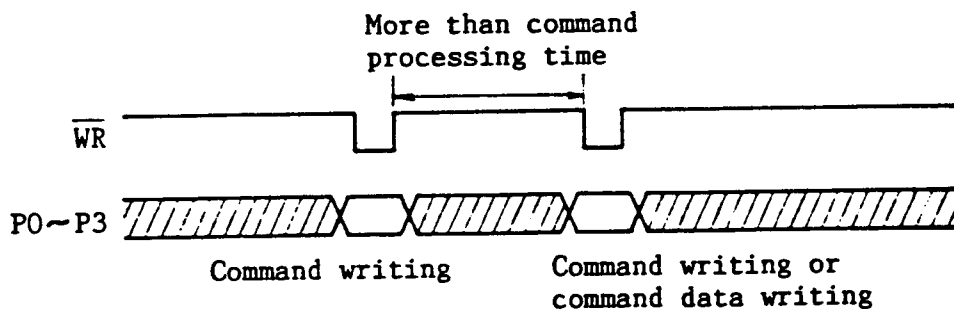

(Example 2)

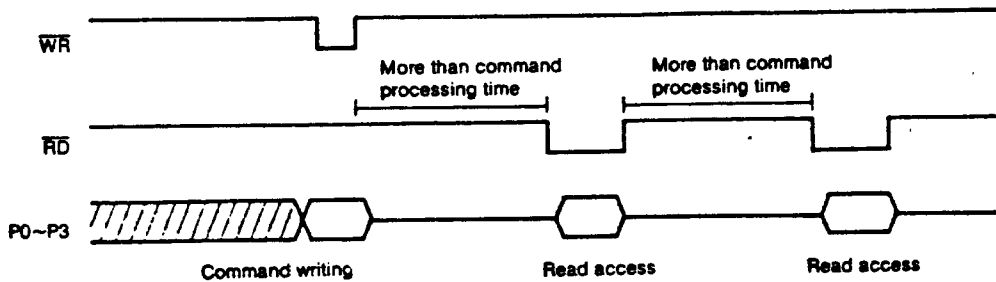

(NOTE) The \overline{WR} and \overline{RD} pulses should be in undisturbed waveforms. Input of disturbed waveform due to power source noise, ringing, etc. can cause malfunction.

5.2.9 Memory map

The memory configurations of RAMs to be connected to the TC8830F are shown below.

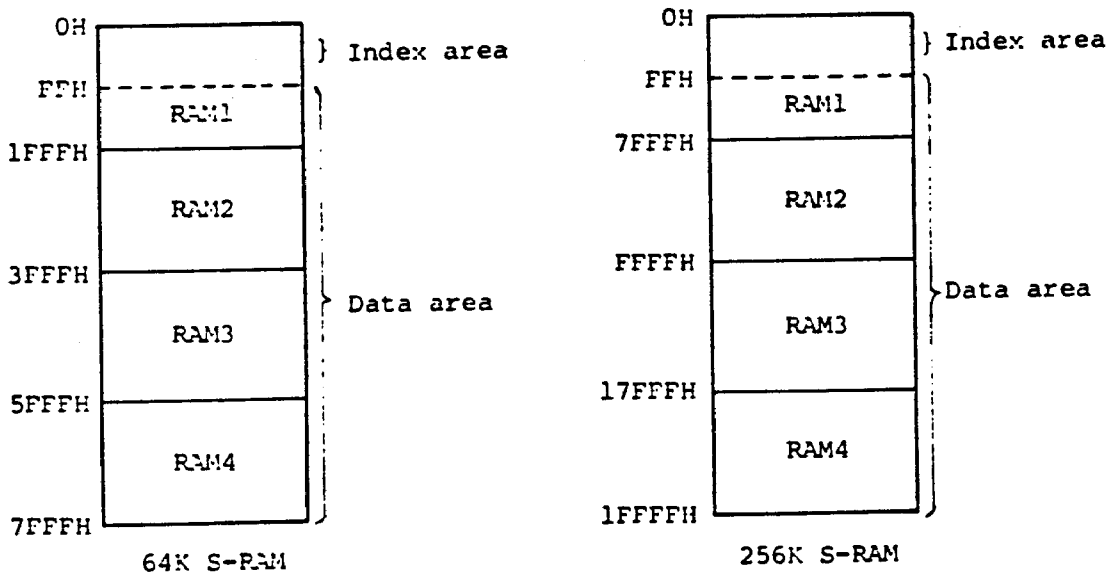

Memory map of index area

| | RAM Address (HEX) | RAM Data | | | | | | | |
|-------------------------------|-------------------|----------|-----|-----|-----|-----|-----|-----|-----|
| | | D7 | D6 | D5 | D4 | D3 | D2 | D1 | D0 |
| Start address of phrase No.0 | 0 | A7 | A6 | A5 | A4 | A3 | A2 | A1 | A0 |
| | 1 | A15 | A14 | A13 | A12 | A11 | A10 | A9 | A8 |
| | 2 | - | - | - | - | A19 | A18 | A17 | A16 |
| | 3 | - | - | - | - | - | - | - | - |
| End address of phrase No.0 | 4 | A7 | A6 | A5 | A4 | A3 | A2 | A1 | A0 |
| | 5 | A15 | A14 | A13 | A12 | A11 | A10 | A9 | A8 |
| Start address of phrase No.1 | 6 | - | - | - | - | A19 | A18 | A17 | A16 |
| | 7 | - | - | - | - | - | - | - | - |
| End address of phrase No.1 | 8 | A7 | A6 | A5 | A4 | A3 | A2 | A1 | A0 |
| | 9 | A15 | A14 | A13 | A12 | A11 | A10 | A9 | A8 |
| Start address of phrase No.2 | A | - | - | - | - | A19 | A18 | A17 | A16 |
| | B | - | - | - | - | - | - | - | - |
| ----- | | | | | | | | | |
| End address of phrase No.60 | F4 | A7 | A6 | A5 | A4 | A3 | A2 | A1 | A0 |
| | F5 | A15 | A14 | A13 | A12 | A11 | A10 | A9 | A8 |
| Start address of phrase No.61 | F6 | - | - | - | - | A19 | A18 | A17 | A16 |
| | F7 | - | - | - | - | - | - | - | - |
| End address of phrase No.61 | F8 | A7 | A6 | A5 | A4 | A3 | A2 | A1 | A0 |
| | F9 | A15 | A14 | A13 | A10 | A11 | A10 | A9 | A8 |
| Start address phrase No.62 | FA | - | - | - | - | A19 | A18 | A17 | A16 |
| | FB | - | - | - | - | - | - | - | - |
| End address of phrase No.62 | FC | A7 | A6 | A5 | A4 | A3 | A2 | A1 | A0 |
| | FD | A15 | A14 | A13 | A12 | A11 | A10 | A9 | A8 |
| | FE | - | - | - | - | - | - | - | - |
| | FF | - | - | - | - | - | - | - | - |

5.3 DMA function

When both the \overline{RD} and \overline{WR} pins are set to "L" level at time of the CPU mode, the $A0 \sim A14$, $D0 \sim D7$, \overline{CE} , $\overline{CE1} \sim \overline{CE4}$ and R/W pins are placed in the high impedance state. This makes it possible to release the connected RAM from the TC8830F.

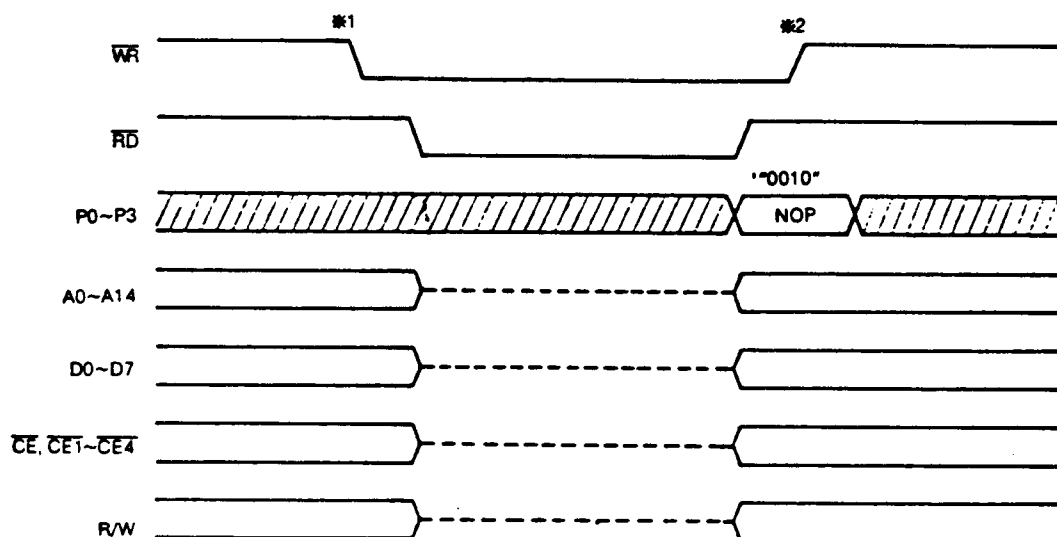

[NOTE] • Use the DMA function in the reproducing waiting state or the recording waiting state.

- #1. Set the \overline{RD} pin at "L" level only after setting the \overline{WR} pin at "L" level. If the \overline{RD} pin is first set at "L" level, the $P0 \sim P3$ pins are placed in the output state until the \overline{WR} pin becomes "L" level.
- #2. Set the \overline{WR} pin at "H" level after setting the \overline{RD} pin at "H" level. At this time, write the NOP command into the TC8830F.

5.4 Standby function

When the STBY pin is at "H" level, the TC8830F is in the standby state. Details of the standby function are described below.

- (1) By stopping oscillation, stops all the internal operations.
- (2) Sets the \overline{CE} and $\overline{CE1} \sim \overline{CE4}$ pins at "H" level and places external RAM in the minimum standby current mode.
- (3) Separates the built-in pull-down resistor from each of the P0 \sim P3, \overline{RD} , \overline{WR} , and PH0 \sim PH3 pins.
- (4) Stops power consumption in the D/A converter.
- (5) Stops power consumption in the microphone amp. 1, microphone amp 2, and band-pass filters.

[NOTE] • The TC8830F cannot be shifted from the recording operation/reproducing operation state to the standby state. Do not set the STBY pin at "H" level during the recording/reproducing operation.

- Under the STBY state, the DAO and FILOUT pins are placed in the high impedance state.

5.5 Initializing operation

When LOW pulse is input to the \overline{ACL} pin, the TC8830F stops all operations and then, performs the initializing operation. Details of the initializing operation are described below.

- (1) Time required for the initializing operation is 32[msec](TYP.) ($f_{OSC}=512$ [kHz]).
- (2) Clears RAM addresses 0H \sim FEH (Index area) and presets the address counter at address 100H.
- (3) At time of the CPU control, sets the TC8830F in the reproducing mode.
- (4) At time of the CPU control, sets the bit rate at 8 Kbps.
- (5) At time of the CPU control, clears OVER bit of the status register.

5.6 S-RAM connecting method

To connect 64Kbit S-RAM 256K pin="L"

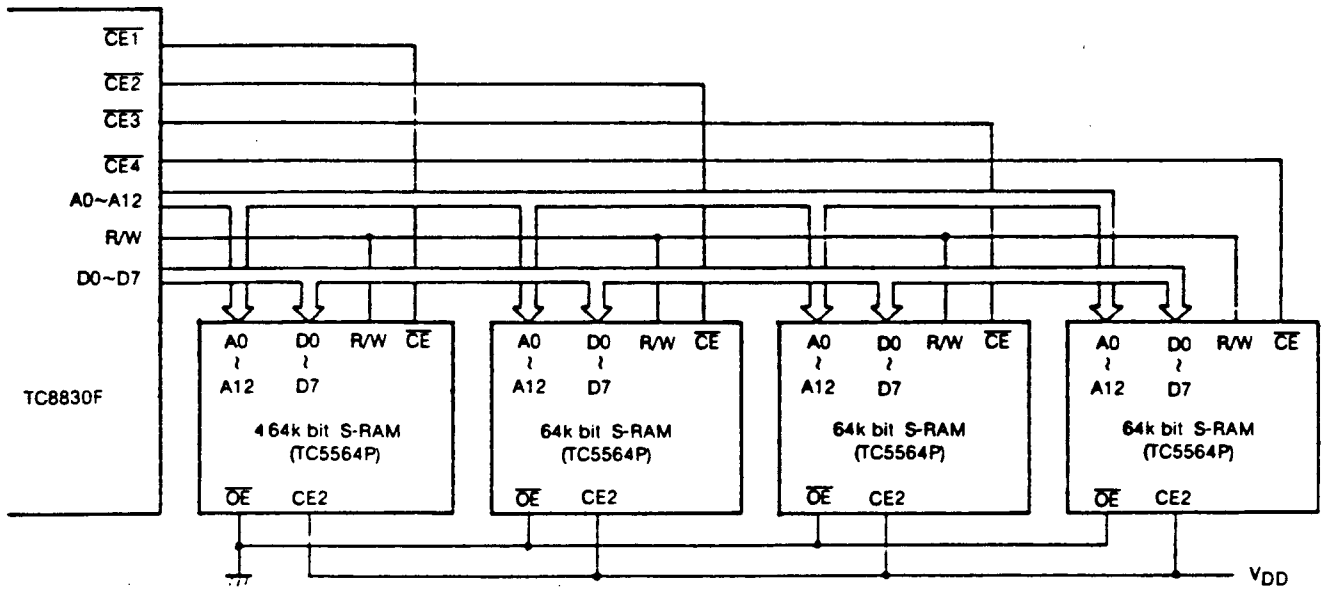

To connect 256Kbit S-RAM 256K pin="H"

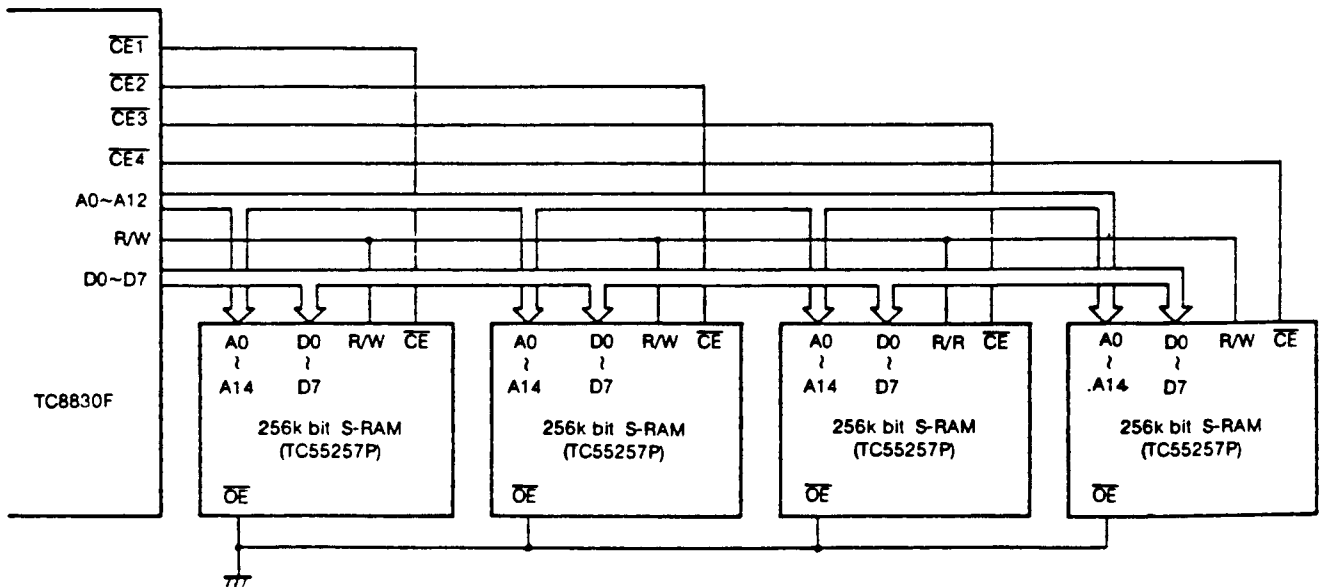

5.7 S-RAM interface timing

Timings for numerals in parentheses in the following flowchart are illustrated from next page.

Recording/reproducing in direct mode

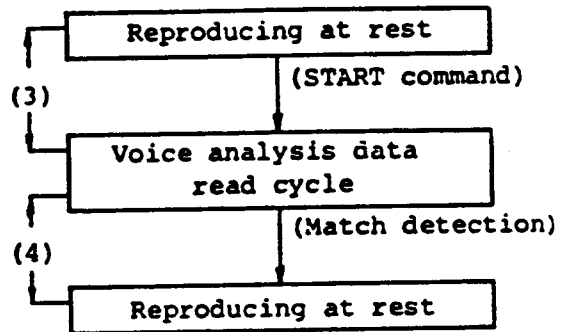
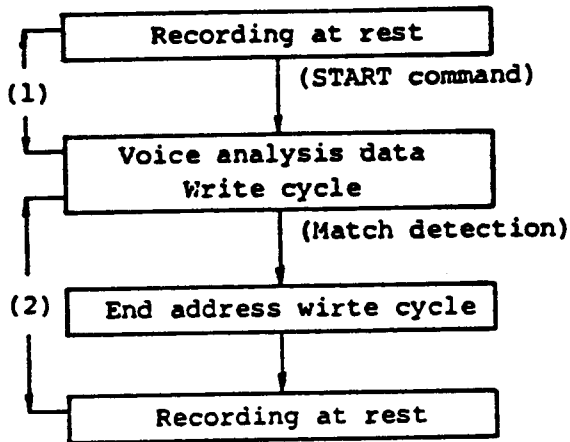

Recording/reproducing in label index mode

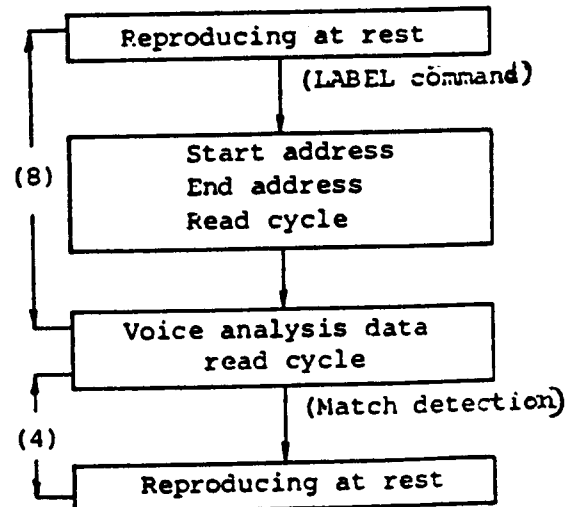
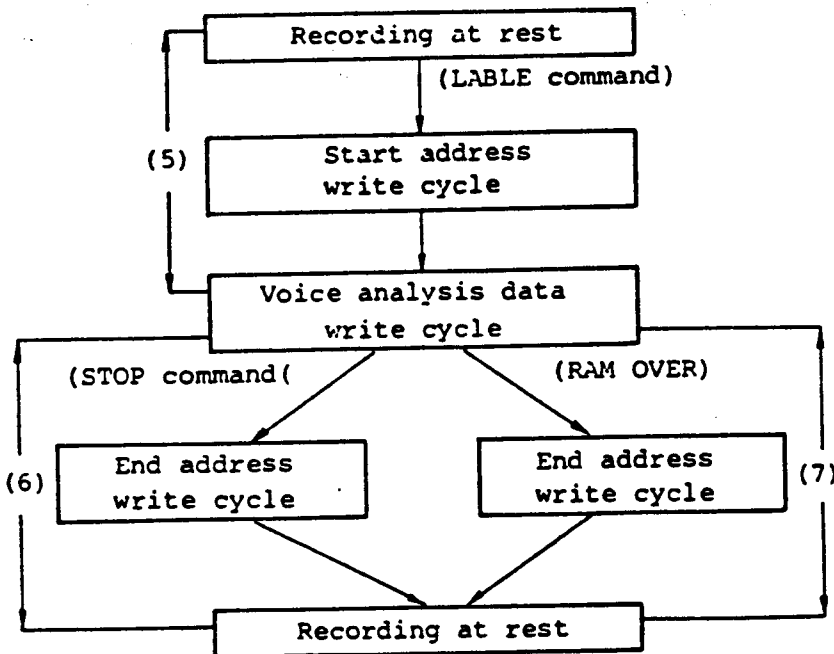

Relation between internal cycle signal and

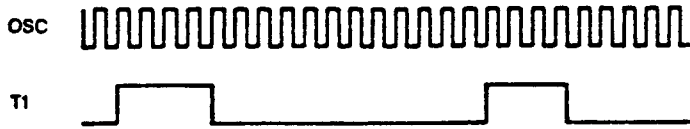

(1)

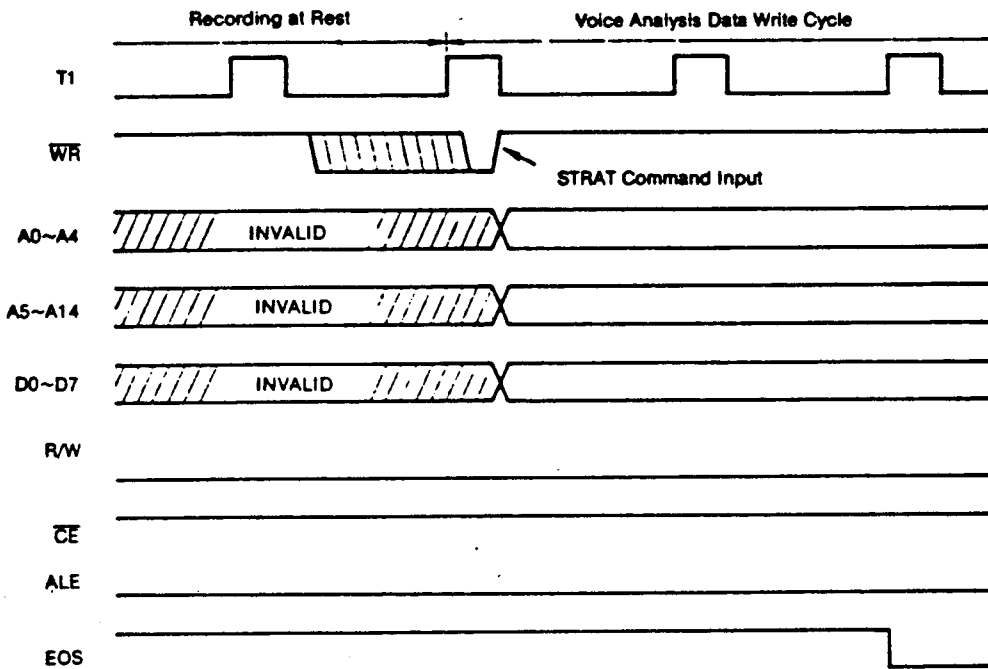

(2)

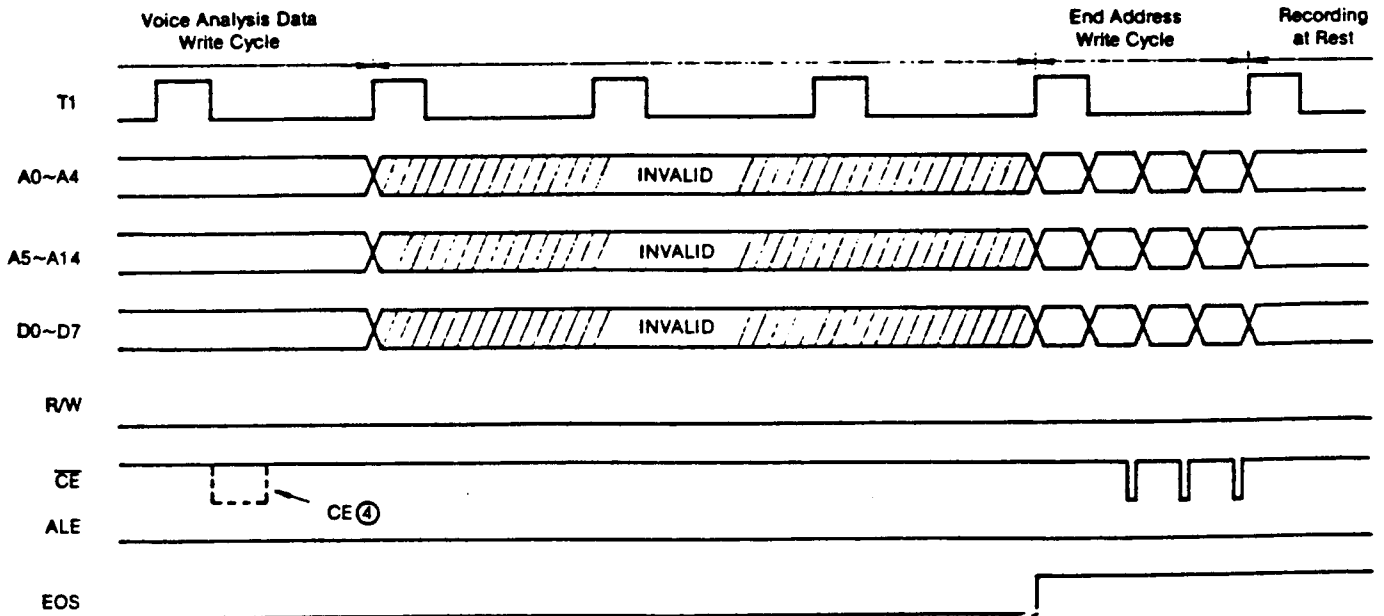

(3)

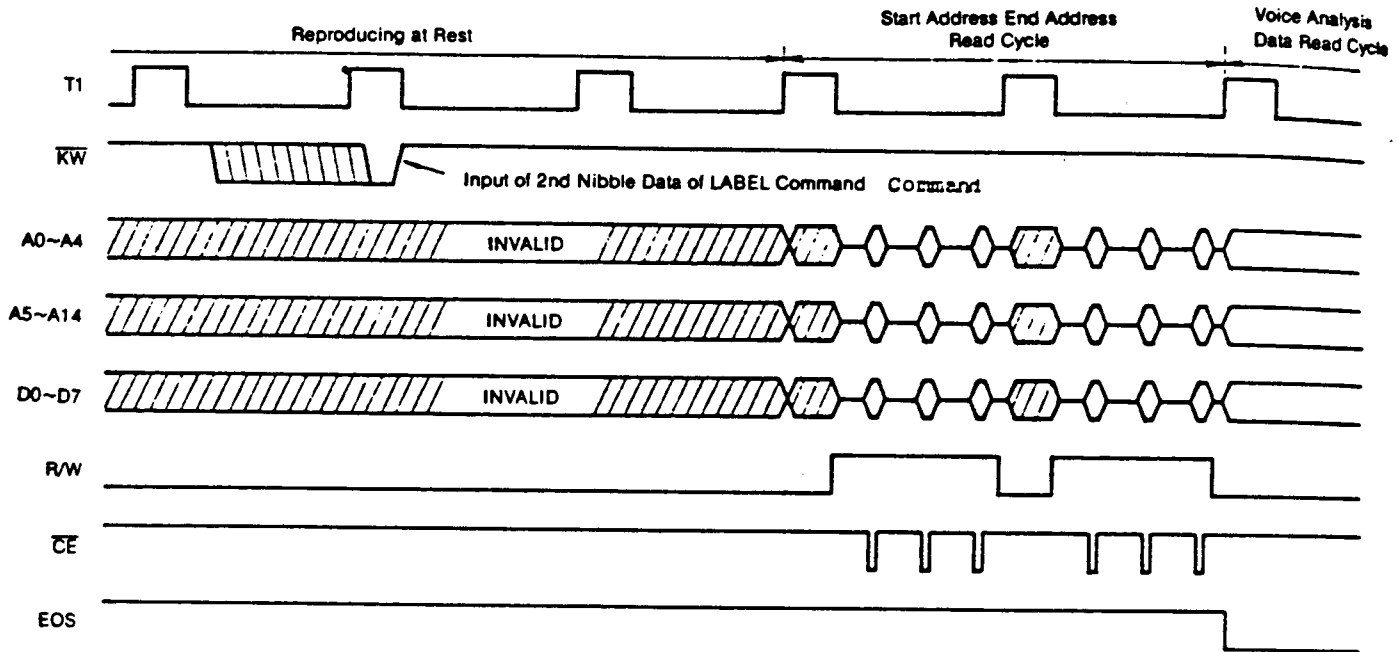

(4)

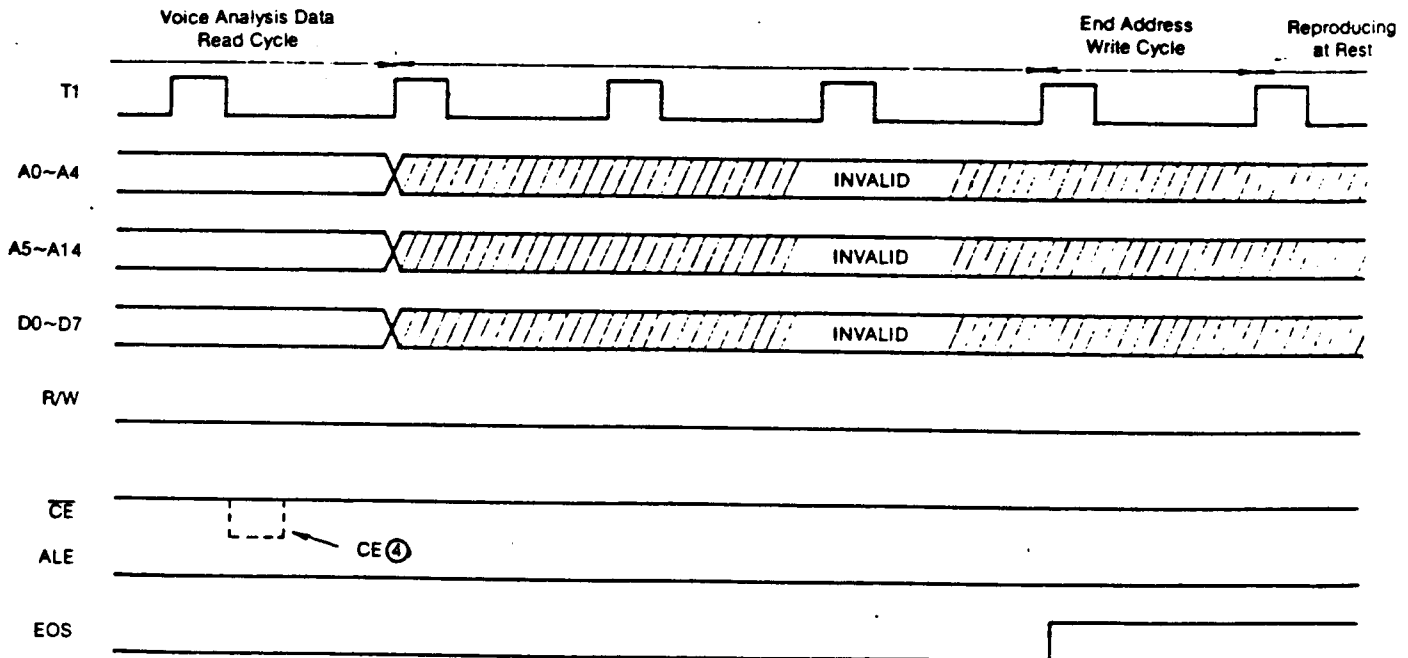

(5)

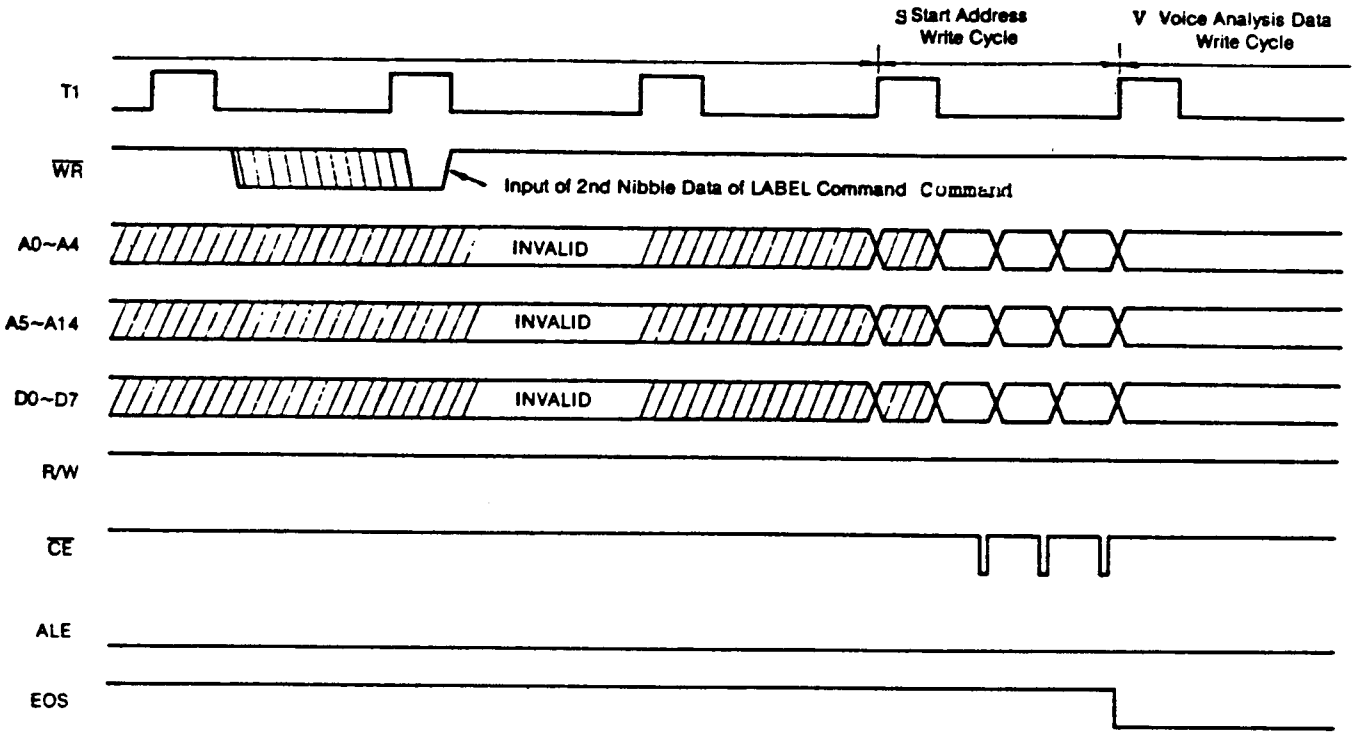

(6)

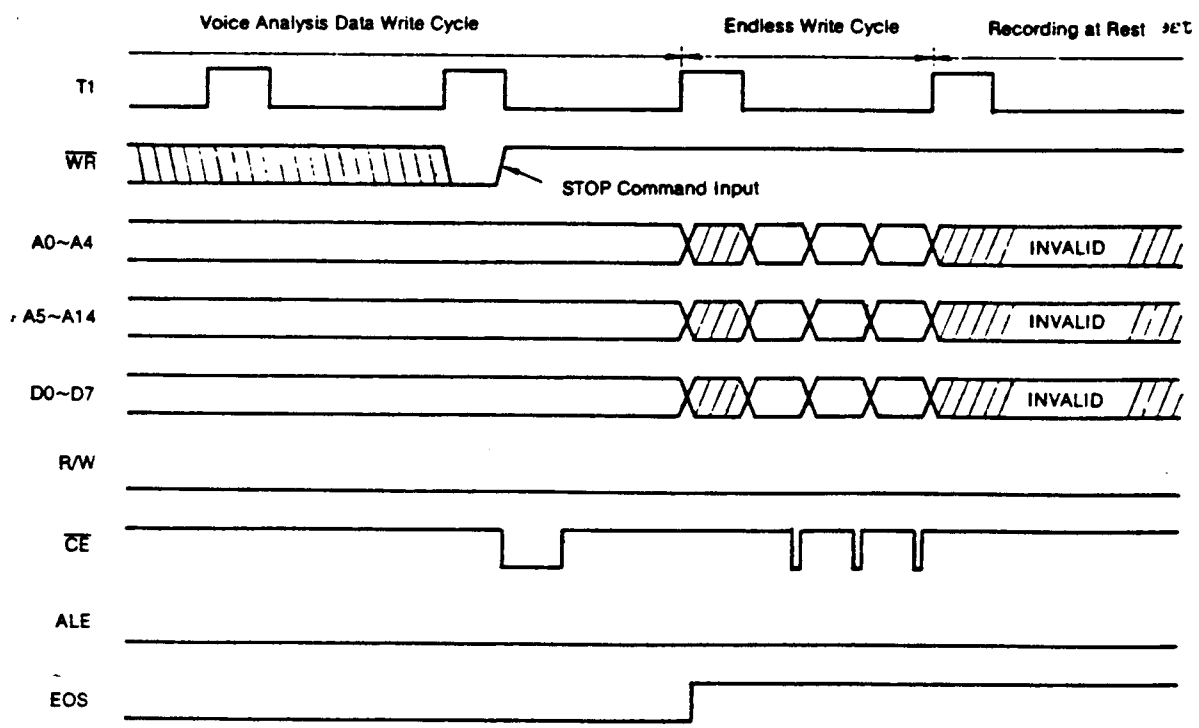

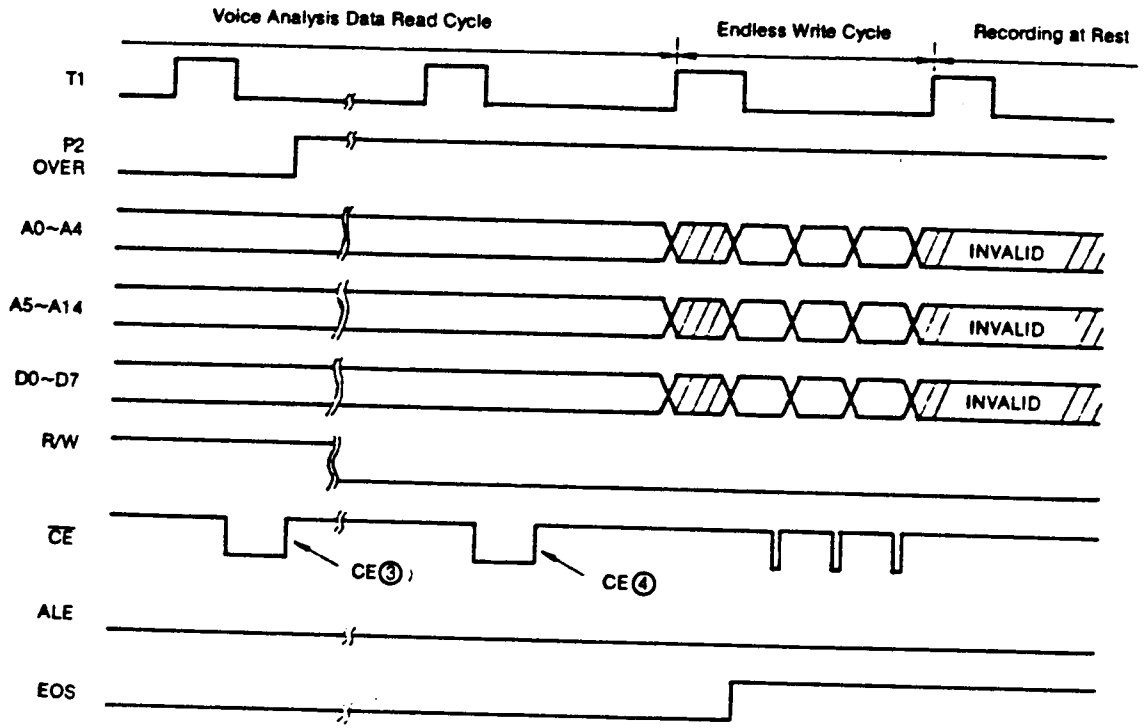

(8)

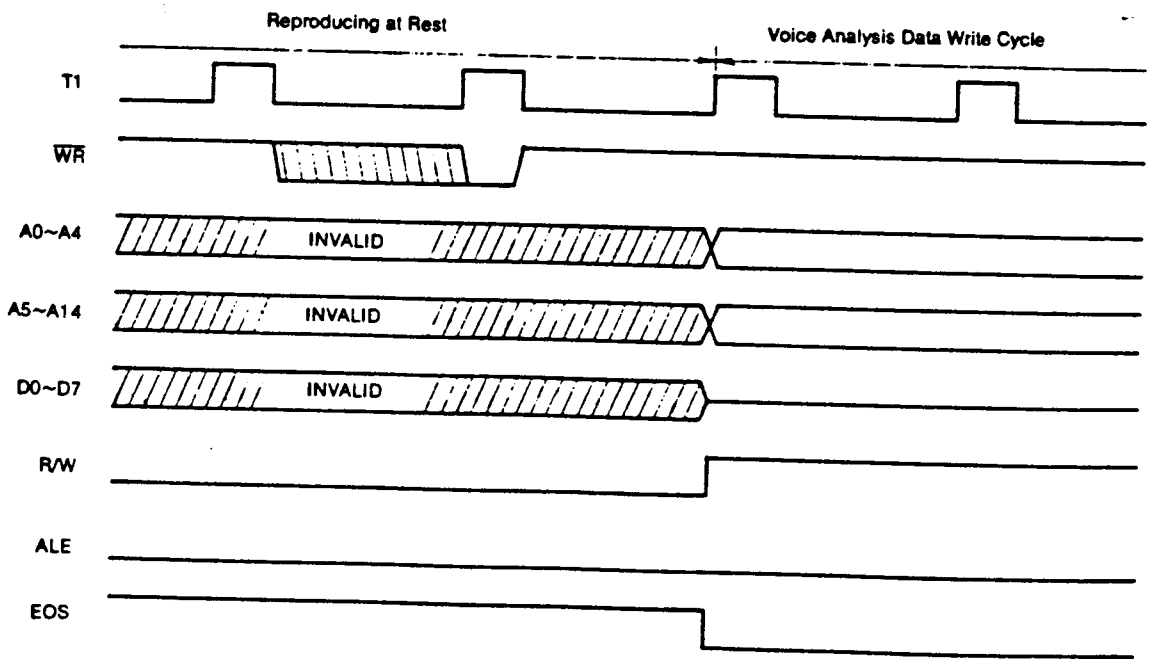

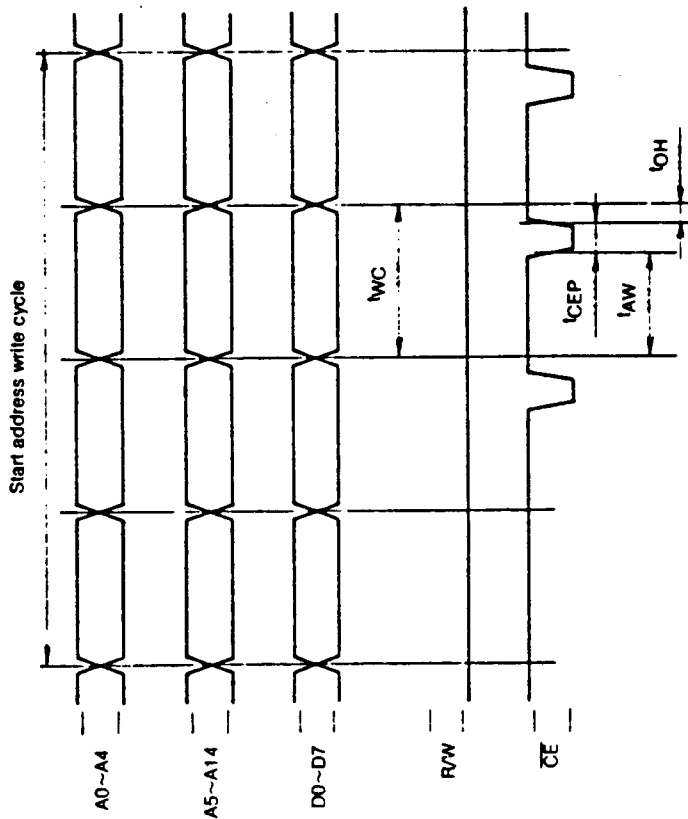
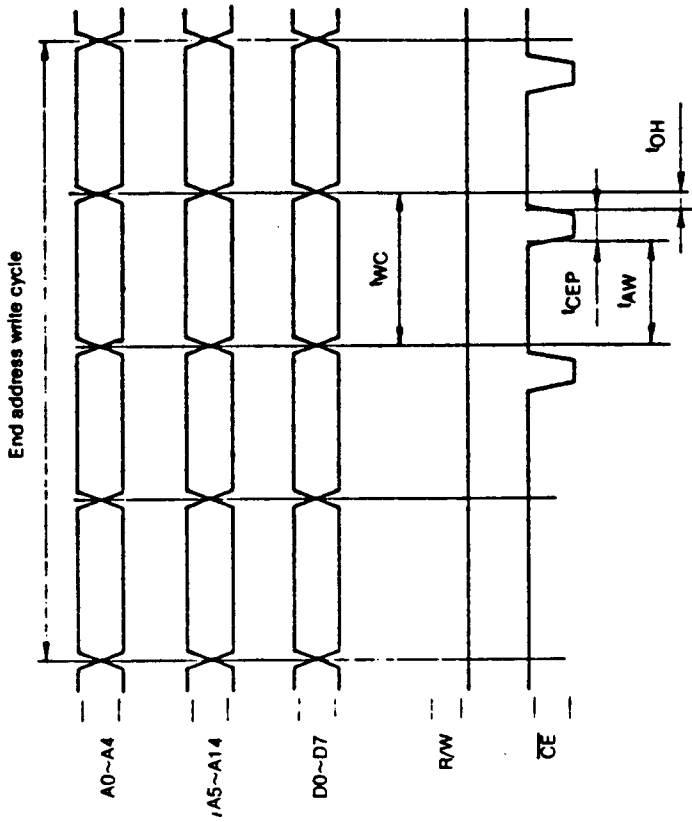

| SYMBOL | ITEM | TYPICAL VALUE |
|-----------|--------------------|---------------|
| t_{WC} | Write cycle time | 8 $t\phi$ |
| t_{CEP} | CE pulse width | 1 $t\phi$ |
| t_{AW} | Address setup time | 6 $t\phi$ |
| t_{DH} | Data hold time | 1 $t\phi$ |

| SYMBOL | ITEM | TYPICAL VALUE |
|-----------|--------------------|---------------|
| t_{WC} | Write cycle time | 8 $t\phi$ |
| t_{CEP} | CE pulse width | 1 $t\phi$ |
| t_{AW} | Address setup time | 6 $t\phi$ |
| t_{DH} | Data hold time | 1 $t\phi$ |

$t\phi=0.98$ [μs] ($f_{OSC}=512$ [kHz])

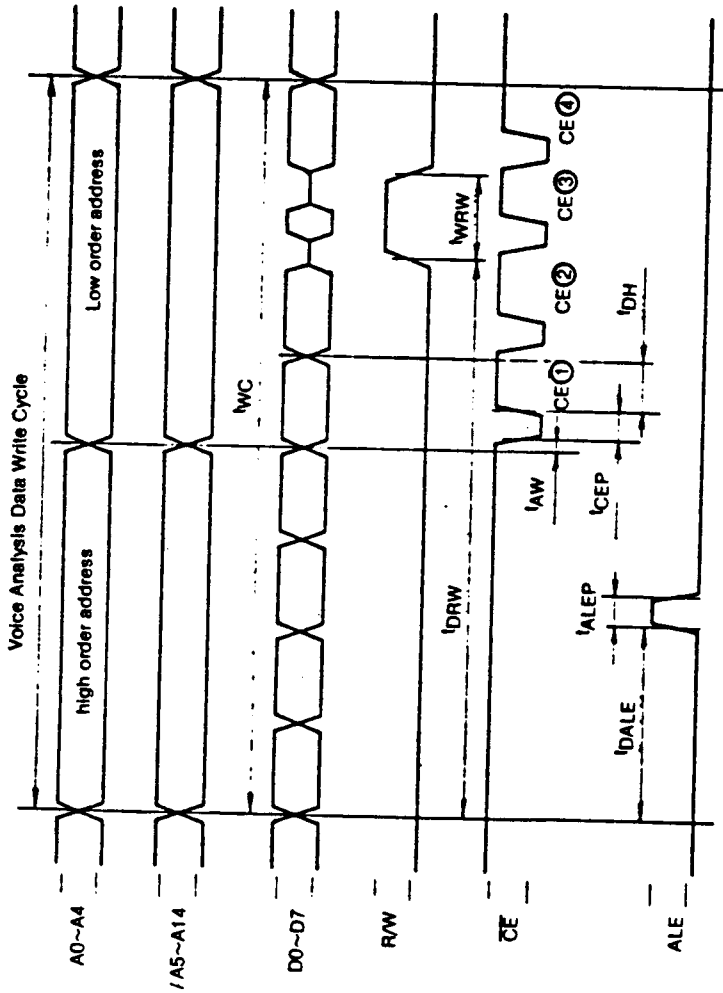

| SYMBOL | ITEM | TYPICAL VALUE | | | |
|------------|--------------------|---------------|--------------|--------------|---------------|
| | | 32kbps | 16kbps | 11kbps | 8kbps |
| t_{WC} | Write cycle time | 256 t ϕ | 512 t ϕ | 768 t ϕ | 1024 t ϕ |
| t_{CEP} | CE pulse width | 8 t ϕ | 8 t ϕ | 8 t ϕ | 8 t ϕ |
| t_{AW} | Address setup time | 8 t ϕ | 8 t ϕ | 8 t ϕ | 8 t ϕ |
| t_{DH} | Data hold time | 16 t ϕ | 48 t ϕ | 80 t ϕ | 112 t ϕ |
| t_{DALE} | ALE Delay time | 72 t ϕ | 136 t ϕ | 200 t ϕ | 264 t ϕ |
| t_{ALEP} | ALE Pulse width | 8 t ϕ | 8 t ϕ | 8 t ϕ | 8 t ϕ |
| t_{DRW} | R/W Delay time | 192 t ϕ | 384 t ϕ | 576 t ϕ | 768 t ϕ |
| t_{WRW} | R/W Rise width | 32 t ϕ | 64 t ϕ | 96 t ϕ | 128 t ϕ |

$t_{\phi} = 0.98 \mu s$ (f_{OSC} = 512 kHz)

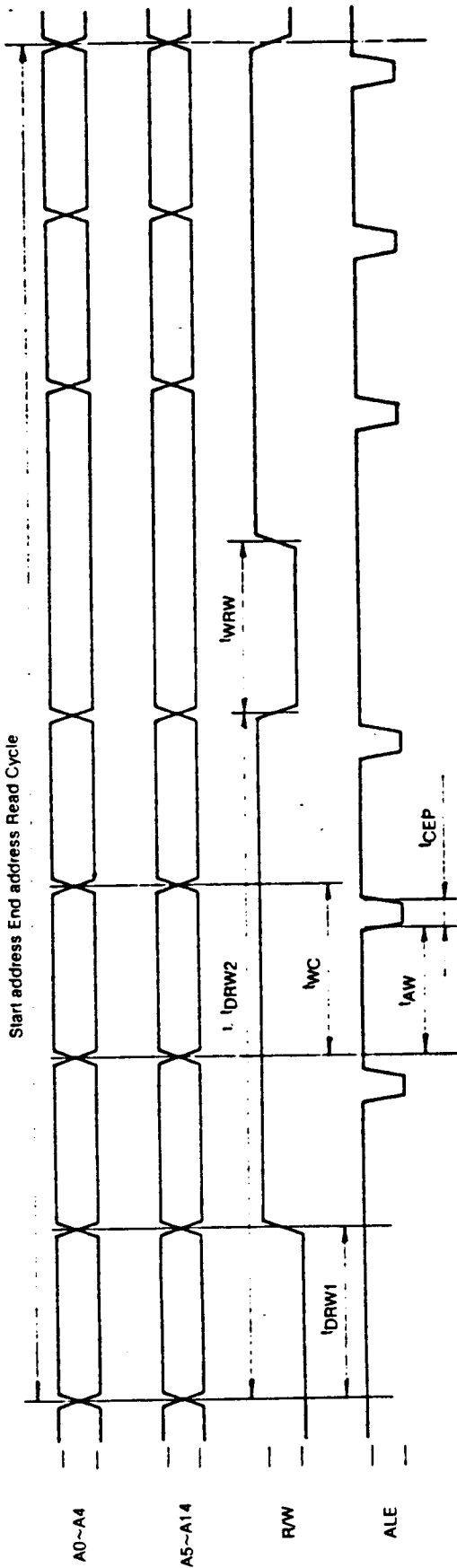

| SYMBOL | ITEM | TYPICAL VALUE |
|--------|--------------------|---------------|
| tWC | Read cycle time | 8 t ϕ |
| tCEP | CE pulse width | 1 t ϕ |
| tAV | Address setup time | 6 t ϕ |
| tDRV1 | R/W delay time 1 | 8 t ϕ |
| tDRV2 | R/W delay time 2 | 32 t ϕ |
| tWRW | R/W rise width | 8 t ϕ |

t ϕ =0.98[μ s] (f_{OSC}=512[kHz])

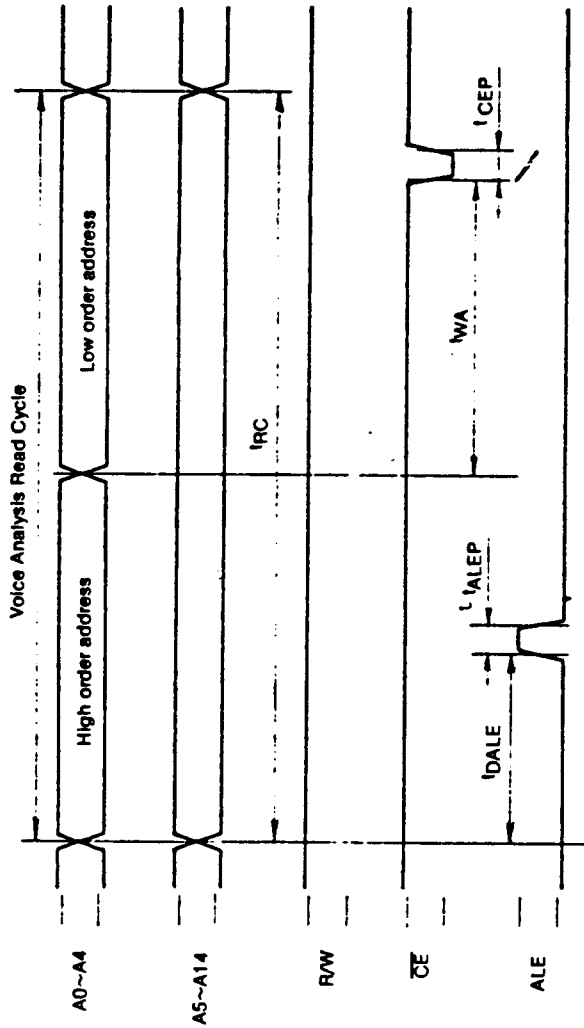

| SYMBOL | ITEM | TYPICAL VALUE | | | |
|------------|--------------------|---------------|-------------|-------------|--------------|
| | | 32kbps | 16kbps | 11kbps | 8kbps |
| t_{RC} | Read cycle time | 256 $t\phi$ | 512 $t\phi$ | 768 $t\phi$ | 1024 $t\phi$ |
| t_{CEP} | CE pulse width | 8 $t\phi$ | 8 $t\phi$ | 8 $t\phi$ | 8 $t\phi$ |
| t_{AV} | Address setup time | 104 $t\phi$ | 200 $t\phi$ | 296 $t\phi$ | 392 $t\phi$ |
| t_{DALE} | ALE delay time | 72 $t\phi$ | 136 $t\phi$ | 200 $t\phi$ | 264 $t\phi$ |
| t_{ALEP} | ALE pulse width | 8 $t\phi$ | 8 $t\phi$ | 8 $t\phi$ | 8 $t\phi$ |

$t\phi=0.98[\mu s]$ ($f_{OSC}=512[kHz]$)

[6] ANALOG PART

The TC8830F has the built-in two-stage microphone amplifiers and band-pass filters. Therefore, a microphone is directly connectable and no external filter is required.

6.1 Microphone amplifiers

The TC8830F contains the two-stage microphone amplifiers; MIC AMP1 gain: 20 times (TYP.), MIC AMP2 gain: 10 times (TYP.). Therefore, gain up to 200 times can be obtained.

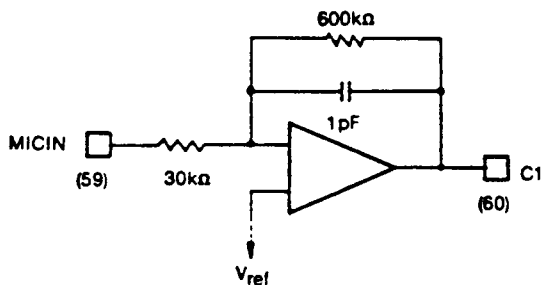

Equivalent circuit of MIC AMP1

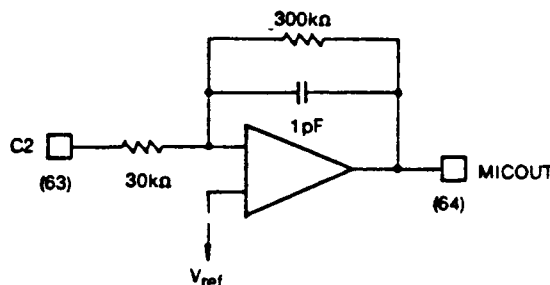

Equivalent circuit of MIC AMP2

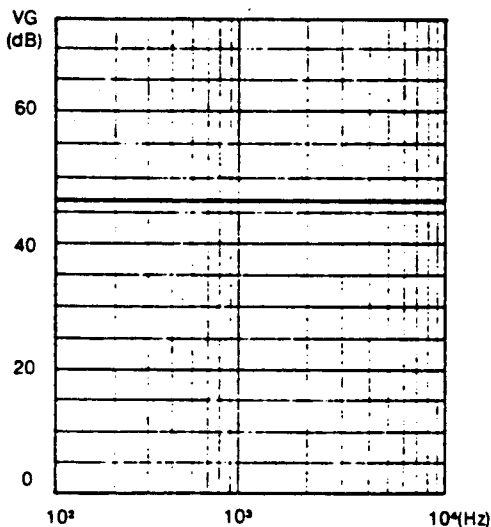

Frequency characteristics of microphone amplifier

- [NOTE]
- Frequency characteristic of the microphone amplifier is that measured between the MICIN pin and MICOUT pin with the C1 pin and C2 pin coupled by a 0.1μF laminated ceramic capacitor.
 - MIC AMP2 becomes valid (power ON) only in the recording operation state.

6.2 Band-pass filter

The band-pass filter consists of the primary high-pass filter and the secondary low-pass filter.

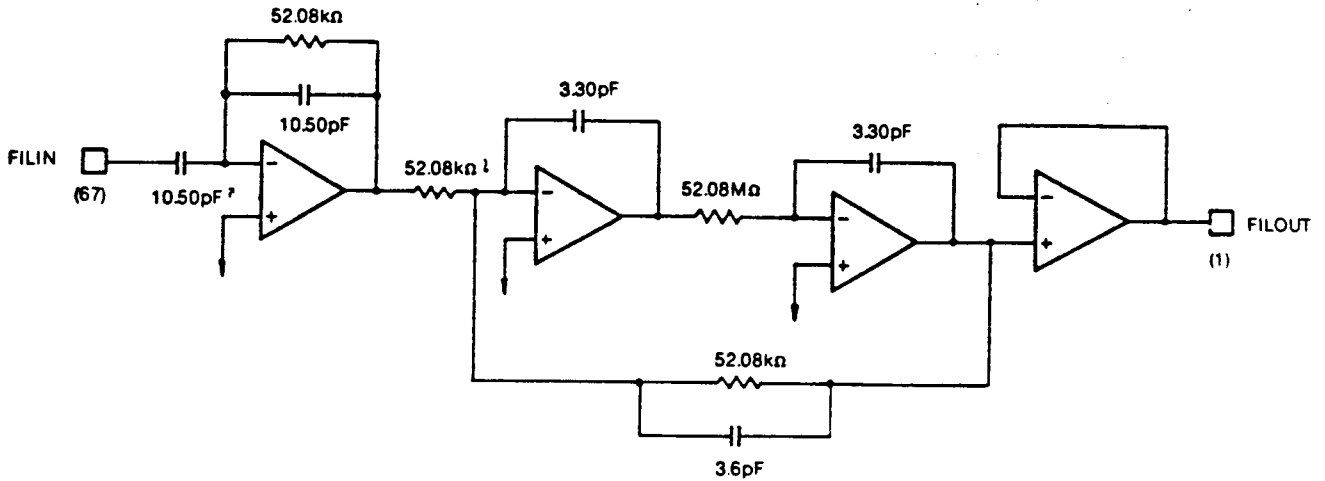

Equivalent circuit of band-pass filter

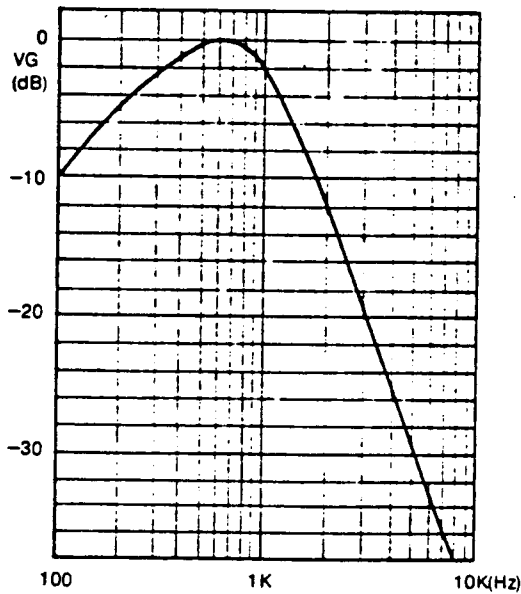

Frequency characteristic of band-pass filter

Frequency characteristic of the band-pass filter is that measured between the FILIN pin and FILOUT Pins.

[7] PIN NAMES AND PIN DESCRIPTION

| PIN NAME | PIN NO. | CONSTRUCTION | | | | FUNCTION |
|-----------------|---------|----------------|----------------------|-------------|----------------------|--|
| | | MANUAL CONTROL | | CPU CONTROL | | |
| | | I/O | PULL-UP PULL-DOWN | I/O | PULL-UP PULL-DOWN | |
| P0 | 54 | | | | | At time of the CPU control, serves as the two-way data bus for exchanging commands and data with external CPU. At time of the manual control, serves as the input terminal (containing PULL DOWN resistor) with the functions shown below. |
| | | Input | Internal pull-down | I/O | None | START input terminal. The recording/reproducing starts when this pin is set to "H" level. |
| P1 | 53 | | | | | STOP input terminal. The recording/reproducing stops when this pin is set to "H" level. |
| P2 | 52 | | | | | Auto phrase input terminal. The auto phrase function becomes valid when this pin is set to "H" level. |
| P3 | 51 | | | | | Recording/reproducing selector terminal. The recording mode at "H" level and the reproducing mode at "L" level. |
| \overline{RD} | 46 | Input | Internal pull-down | Input | None | Read pulse input terminal at time of the CPU control. Serves as the bit rate selection input terminal at time of the manual control. |
| \overline{WR} | 45 | Input | Internal pull-down | Input | None | Write pulse input terminal at the CPU control. Serves as the bit rate selection input terminal at time of the manual control mode. |

TOSHIBA INTEGRATED CIRCUIT

TECHNICAL DATA

TC8830F

| PIN NAME | PIN NO. | CONSTRUCTION | | | | FUNCTION |
|---|--|----------------|-----------------------|-------------|-----------------------|--|
| | | MANUAL CONTROL | | CPU CONTROL | | |
| | | I/O | PULL-UP PULL-DOWN | I/O | PULL-UP PULL-DOWN | |
| EOS | 55 | Output | - | Output | - | End of Speech output terminal. This pin is at "H" level in the recording waiting state and the reproducing waiting state, while it becomes "L" level in the recording operation and the reproducing operation state. |
| CPUM | 57 | Input | None | Input | None | Manual control/CPU control selector terminal. The manual control when this pin is at "L" level and the CPU control at "H" level. |
| PH0 PH1 PH2 PH3 | 50 49 48 47 | Input | Internal pull-down | Input | Internal pull-down | Phrase selection input terminals. Max. 16 phrases are selectable at 4-bit codes. (PH0=LSB, PH3=MSB) Valid only in the manual control mode and becomes invalid in the CPU control mode. |
| 256K | 42 | Input | None | Input | None | Sets at "L" level when 64kbit S-RAM is used and at "H" level for 256kbit S-RAM. |
| A0 A1 A2 A3 A4 A5 A6 A7 A8 A9 A10 A11 A12 A13 A14 | 33 32 31 30 29 28 26 25 24 23 22 21 19 18 17 | Output | - | Output | - | RAM address output, terminals. Connect to S-RAM address inputs. When 64kbit S-RAM is used, use only A0~A12 pins. A0~A4 pins output A0~A4 or A15~A19 at time sharing. At time of the CPU control, these pins are placed in the high impedance state by the DMA function. |

TOSHIBA INTEGRATED CIRCUIT

TECHNICAL DATA

TC8830F

| PIN NAME | PIN NO. | CONSTRUCTION | | | | FUNCTION |
|--|---|----------------|----------------------|-------------|----------------------|--|
| | | MANUAL CONTROL | | CPU CONTROL | | |
| | | I/O | PULL-UP PULL-DOWN | I/O | PULL-UP PULL-DOWN | |
| D0 D1 D2 D3 D4 D5 D6 D7 | 16 15 14 13 10 8 6 4 | I/O | None | I/O | None | RAM data input/output terminals. Connect to S-RAM data terminals. At time of the CPU control, these pins are placed in the high impedance state by the DNA function. |
| $\overline{CE1}$ $\overline{CE2}$ $\overline{CE3}$ $\overline{CE4}$ | 35 36 37 38 | Output | - | Output | - | RAM chip enable output terminals. According to quantity of S-RAM to be used, use these in order of $\overline{CE1} \sim \overline{CE4}$ pins. At time of the CPU control, these pins are placed in the high impedance state. |
| \overline{CE} | 34 | Output | - | Output | - | RAM chip enable output terminal. Used at time of memory expansion. At time of the CPU control, this pin is placed in the high impedance state by the DNA function. |
| R/W | 43 | Output | - | Output | - | RAM read/write output terminal. Connect to S-RAM R/W pin. At time of the CPU control, this pin is placed in the high impedance state by the DNA function. |
| ALE | 44 | Output | - | Output | - | Memory expansion output terminal. Indicates output timing of the internal address counter A15 ~ A19 of the TC8830F to the A0 ~ A4 pins. |
| STBY | 39 | Input | None | Input | None | Standby input terminal. The TC8830F is placed in the standby state when this pin is set at "H" level. |

TOSHIBA INTEGRATED CIRCUIT

TECHNICAL DATA

TC8830F

| PIN NAME | PIN NO. | CONSTRUCTION | | | | FUNCTION |
|------------------|----------|----------------|----------------------|--------------|----------------------|--|
| | | MANUAL CONTROL | | CPU CONTROL | | |
| | | I/O | PULL-UP PULL-DOWN | I/O | PULL-UP PULL-DOWN | |
| XIN | 40 | Input | None | Input | None | Oscillation circuit input/output terminals. Connect a 512kHz ceramic oscillator and a capacitor. In case of external clock input, supply it to the XIN pin and keep the XOUT pin open. |
| XOUT | 41 | Output | - | Output | - | |
| \overline{ACL} | 56 | Input | Pull-up | Input | Pull-up | Reset signal input terminal. |
| MICIN | 59 | Input | None | Input | None | MIC AMP1 input terminal. |
| C1 | 60 | Output | - | Output | - | MIC AMP1 output terminal. |
| C2 | 63 | Output | None | Input | None | MIC AMP2 input terminal. |
| MICOUT | 64 | Output | - | Output | - | MIC AMP2 output terminal. |
| ADI | 65 | Input | None | Input | None | Voice analysis circuit input terminal. |
| DAO | 66 | Output | - | Output | - | D/A converter output terminal. |
| FILIN | 67 | Input | None | Input | None | Band-pass filter input terminal. |
| FILOUT | 1 | Output | - | Output | - | Band-pass filter output terminal. |
| Vref | 58 | Output | - | Output | - | Analog circuit reference voltage output terminal. |
| TEST | 3 | Input | Pull-up | Input | Pull-down | Test circuit terminal. Connect nothing to this pin. |
| VDD | 27 61 | Power supply | - | Power supply | - | Power supply terminal. Supply +5V. |
| VSS1 VSS2 | 20 62 | Power supply | - | Power supply | - | Power supply terminal. Connect to GND of power source. VSS1 is for the digital circuit, while VSS2 is for the analog circuit. |

[8] PIN CONNECTIONS

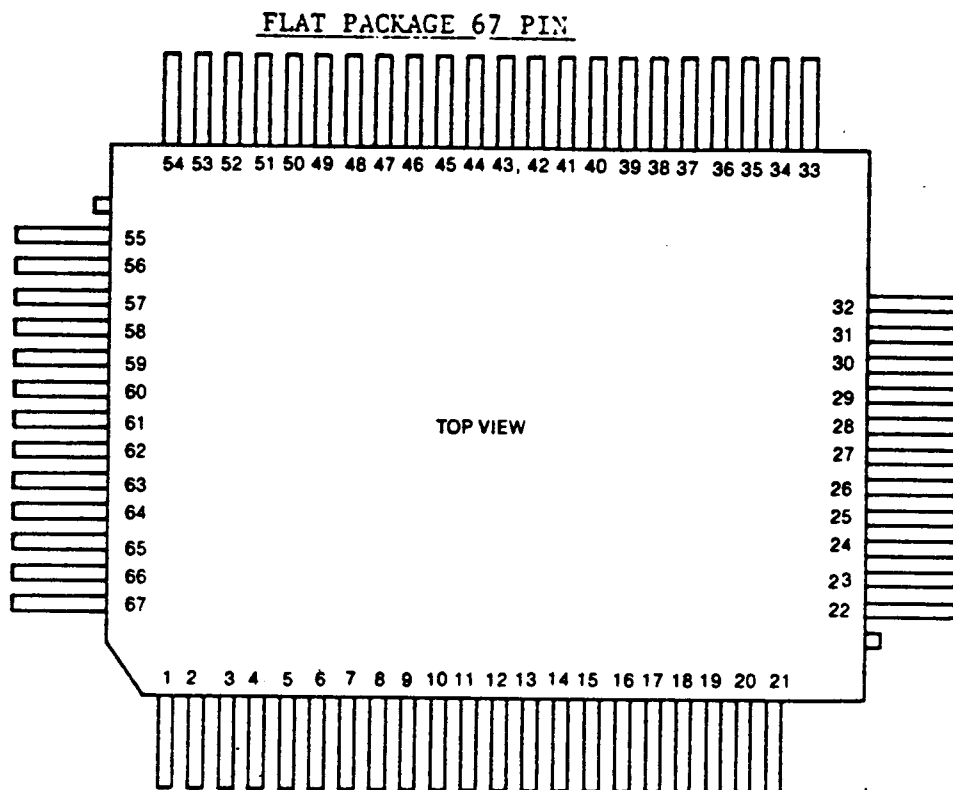

| | | | | | | | |
|----|--------|----|-----------------|----|------------------|----|------------------|
| 1 | FILOUT | 18 | A13 | 35 | $\overline{CE1}$ | 52 | P2 |
| 2 | N.C. | 19 | A12 | 36 | $\overline{CE2}$ | 53 | P1 |
| 3 | TEST | 20 | VSS1 | 37 | $\overline{CE3}$ | 54 | P0 |
| 4 | D7 | 21 | A11 | 38 | $\overline{CE4}$ | 55 | EOS |
| 5 | N.C. | 22 | A10 | 39 | STBY | 56 | \overline{ACL} |
| 6 | D6 | 23 | A9 | 40 | XIN | 57 | CPUM |
| 7 | N.C. | 24 | A8 | 41 | XOUT | 58 | Vref |
| 8 | D5 | 25 | A7 | 42 | 256K | 59 | MICIN |
| 9 | N.C. | 26 | A6 | 43 | R/W | 60 | C1 |
| 10 | D4 | 27 | VDD | 44 | ALE | 61 | VDD |
| 11 | N.C. | 28 | A5 | 45 | \overline{WR} | 62 | VSS2 |
| 12 | N.C. | 29 | A4 | 46 | \overline{RD} | 63 | C2 |
| 13 | D3 | 30 | A3 | 47 | PH3 | 64 | MICOUT |
| 14 | D2 | 31 | A2 | 48 | PH2 | 65 | ADI |
| 15 | D1 | 32 | A1 | 49 | PH1 | 66 | DAO |
| 16 | D0 | 33 | A0 | 50 | PH0 | 67 | FILIN |
| 17 | A14 | 34 | \overline{CE} | 51 | P3 | | |

[9] OUTLINE DRAWINGS

67 PIN FLAT PACKAGE (67-4-BS)

Unit: mm

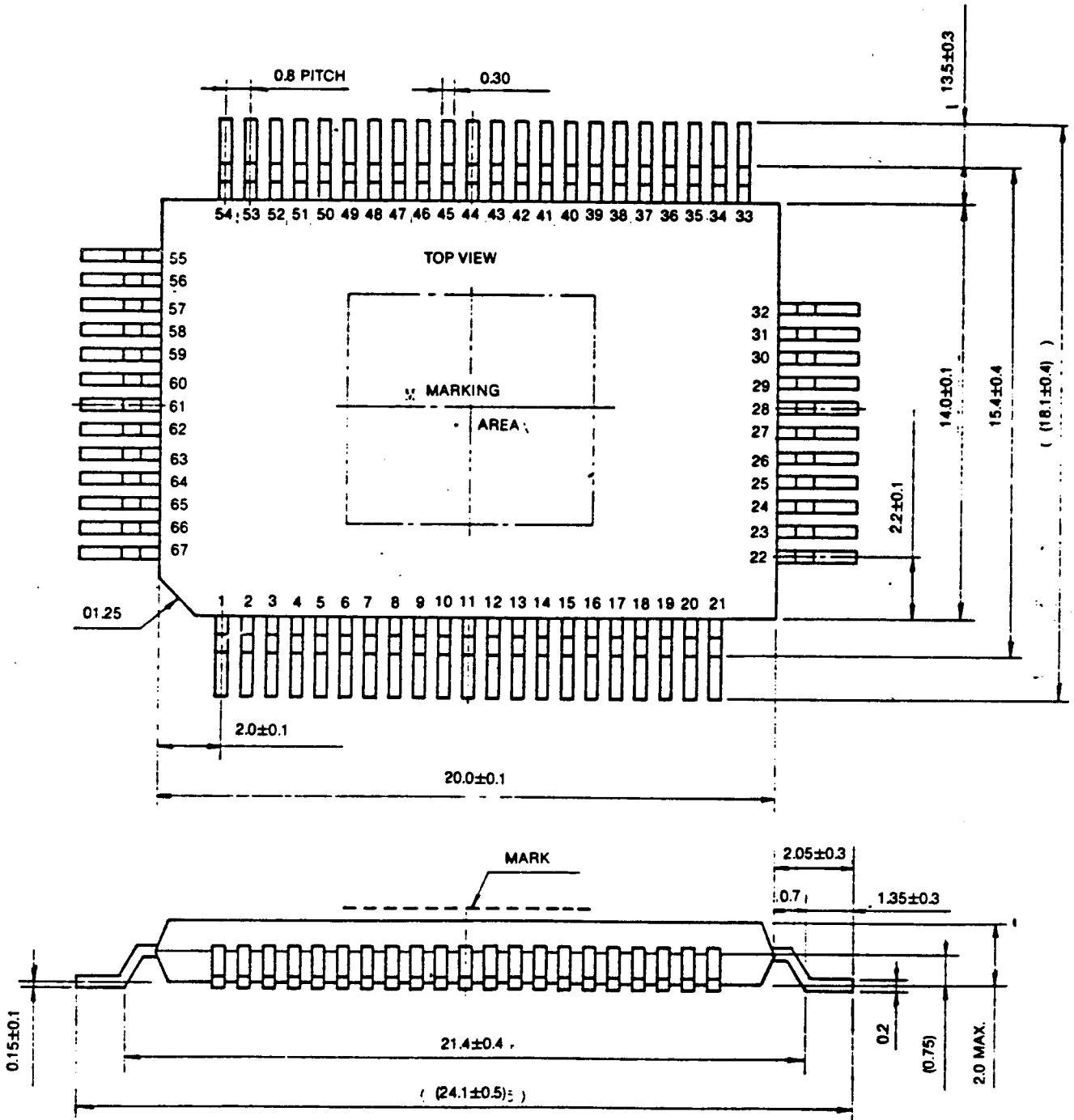

[10] ELECTRICAL CHARACTERISTICS

10.1 Absolute maximum rating

| SYMBOL | ITEM | RATING | UNIT |
|------------------|-----------------------|-----------------------------|------|
| V _{DD} | Supply Voltage | -0.3 ~ 6.5 | V |
| V _{IN} | Input Voltage | -0.3 ~ V _{DD} +0.3 | V |
| V _{OUT} | Output Voltage | -0.3 ~ V _{DD} +0.3 | V |
| T _{OPR} | Operating Temperature | -10 ~ 55 | °C |
| T _{STG} | Storage Temperature | -55 ~ 125 | °C |

TOSHIBA INTEGRATED CIRCUIT

TECHNICAL DATA

TC8830F

10.2 DC Characteristics (Unless otherwise specified, $V_{DD}=5V$ 10%, $T_a=25^\circ C$, $V_{SS1}=V_{SS2}=0$)

| SYMBOL | ITEM | APPLIED TERMINAL | TEST CONDITION | STANDARD VALUE | | | UNIT |
|-------------------|--------------------------------|---|---|----------------|------|------|------|
| | | | | MIN. | TYP. | MAX. | |
| f _{OPR} | Operating frequency | | $V_{DD}=4.5\sim 6.5V$ | 400 | 512 | 600 | kHz |
| V _{OPR} | Operating supply voltage | | $f=400\sim 600kHz$ | 4.5 | - | 6.5 | V |
| I _{DD1} | Consumption current (1) | V _{SS1} (Logic part) | At no load/ no signal | - | - | 3.0 | mA |
| I _{DD2} | Consumption current (2) | V _{SS2} (Analog part) | At no load/ no signal | - | - | 3.0 | |
| I _{DD3} | Consumption current at standby | | At no load/ no signal* | - | - | 3.0 | μA |
| V _{IH} | Input high voltage | All input terminals | | 3.4 | - | - | V |
| V _{IL} | Input low voltage | | | - | - | 0.60 | |
| V _{OH} | Output High voltage | P0~P3, D0~D7, ALE EOS, R/W, A0~A14 | No load | 4.2 | - | - | |
| V _{OL} | Output low voltage | \overline{CE} , $\overline{CE1}\sim\overline{CE4}$ | No load | - | - | 0.3 | |
| I _{OH} | Output high current | ALE, EOS, A0~A14 D0~D7, P0~P3, \overline{CE} $\overline{CE1}\sim\overline{CE4}$, R/W | $V_{OH}=2.4V$ TEST=256K= V_{DD} | 0.4 | - | - | mA |
| I _{OL} | Output low current | ALE, EOS, A0~A14 D0~D7, P0~P3, \overline{CE} $\overline{CE1}\sim\overline{CE4}$, R/W | $V_{OL}=0.4V$ TEST= V_{DD} | 0.4 | - | - | |
| I _{IH1} | Input high current (1) | P0~P3, PH0~PH3 \overline{RD} , \overline{WR} | $V_{IH}=V_{DD}$ CPUM= V_{SS} | 10 | 50 | 150 | μA |
| I _{IH2} | Input high current (2) | P0~P3, PH0~PH3 \overline{RD} , \overline{WR} | $V_{IH}=V_{DD}$ CPUM= V_{DD} | - | - | 1.0 | |
| I _{IH3} | Input high current (3) | TEST | $V_{IH}=V_{DD}$ | 50 | 100 | 500 | |
| I _{IH4} | Input high current (4) | 256K, STBY, CPUM | $V_{IH}=V_{DD}$ | - | - | 1.0 | |
| I _{IH5} | Input high current (5) | A0~A14, D0~D7, \overline{CE} $\overline{CE1}\sim\overline{CE4}$, R/W | $V_{IH}=CPUM=V_{DD}$ $\overline{RD}=\overline{WR}=V_{SS}$ | - | - | 1.0 | |
| I _{IL1} | Input low current (1) | P0~P3, PH0~PH3, \overline{RD} , \overline{WR} , TEST, 256K STBY, CPUM | $V_{IL}=V_{SS}$ | - | - | 1.0 | |
| I _{IL2} | Input low current (2) | \overline{ACL} | $V_{IL}=V_{SS}$ | - | - | 1.0 | |
| I _{IL3} | Input low current (3) | D0~D7 | $V_{IL}=V_{SS}$ | 10 | 50 | 150 | |
| I _{IL4} | Input low current (4) | A0~A14, D0~D7, \overline{CE} $\overline{CE1}\sim\overline{CE4}$, R/W | CPUM= V_{DD} $V_{IL}=\overline{RD}=\overline{WR}=V_{SS}$ | - | - | 1.0 | |
| V _{OLT1} | Output voltage (1) | VREF | | - | 2.8 | - | V |

* STBY pin: $V_{DD}+0.0[V]$, $-0.2[V]$

[NOTE] Max. and Min. values given are defined by their absolute values.

10.3 AC Characteristics

10.3.1 At data read

| SYMBOL | ITEM | MIN. | MAX. | UNIT |
|-----------|---------------------|------|------|------|
| t_{ACC} | Access time | 400 | - | ns |
| t_{OD} | Output disable time | - | 300 | ns |

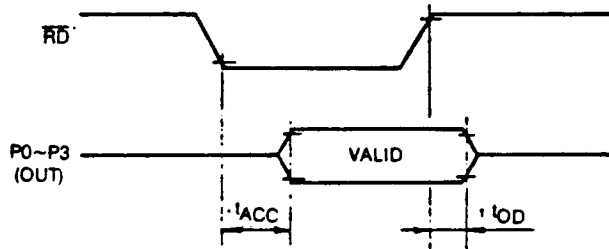

10.3.2 At data write

| SYMBOL | ITEM | MIN. | MAX. | UNIT |
|-----------|-----------------------------|------|------|---------|
| t_{DS} | Data setup time | 600 | - | μ s |
| t_{DH} | Data hold time | 0 | - | μ s |
| t_{WRP} | \overline{WR} pulse width | 400 | - | ns |

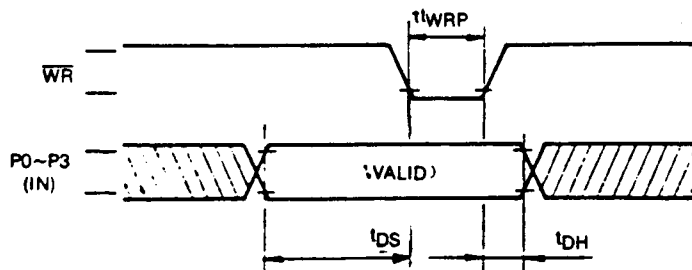

10.3.3 \overline{ACL} pulse width

| SYMBOL | ITEM | MIN. | MAX. | UNIT |
|-------------|------------------------------|------|------|---------|
| $t_{ACL P}$ | \overline{ACL} pulse width | 1 | - | μs |



10.3.4 At memory data access

| | | | | |
|----------|--|-----|---|----|
| t_{SD} | Memory data setup time to \overline{CE} rise | 800 | - | ns |
| t_{HD} | Memory data hold time | 0 | - | ns |

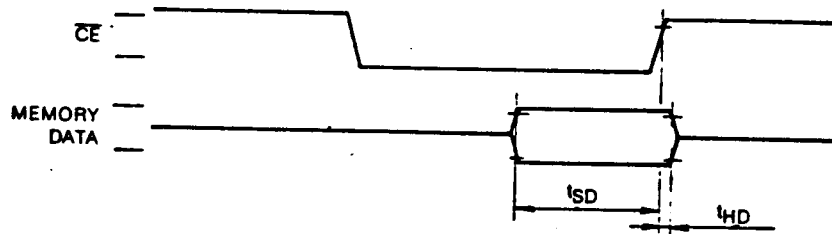

10.3.5 \overline{CE} signal delay time

| SYMBOL | ITEM | MIN. | MAX. | UNIT |
|------------|--|------|------|------|
| t_{DLCE} | Delay time up to \overline{CE} "L" to clock fall | - | 400 | ns |
| t_{DHCE} | Delay time up to \overline{CE} "H" to clock rise | - | 400 | ns |

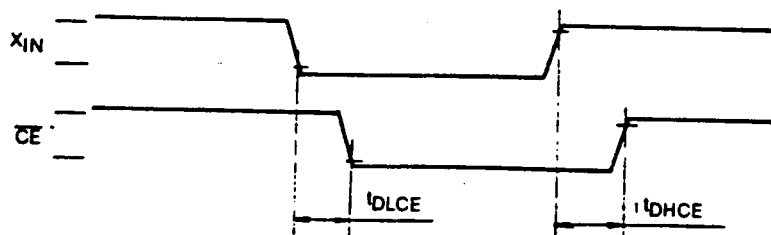

10.3.6 DMA Function

| SYMBOL | ITEM | MIN. | MAX. | UNIT |
|-------------|--|------|------|---------|
| t_{WRL} | Time from \overline{WR} fall to \overline{RD} fall | 100 | | ns |
| $t_{DR(Z)}$ | Delay time from \overline{RD} fall to Hi-Z | | 300 | ns |
| t_{RWL} | Time from \overline{RD} rise to \overline{WR} rise | 100 | | ns |
| $t_{DW(O)}$ | Time from \overline{WR} rise to Output state | | 300 | ns |
| t_{DS} | Data setup time | 1 | | μ s |
| t_{DH} | Data Hold time | 0 | | μ s |

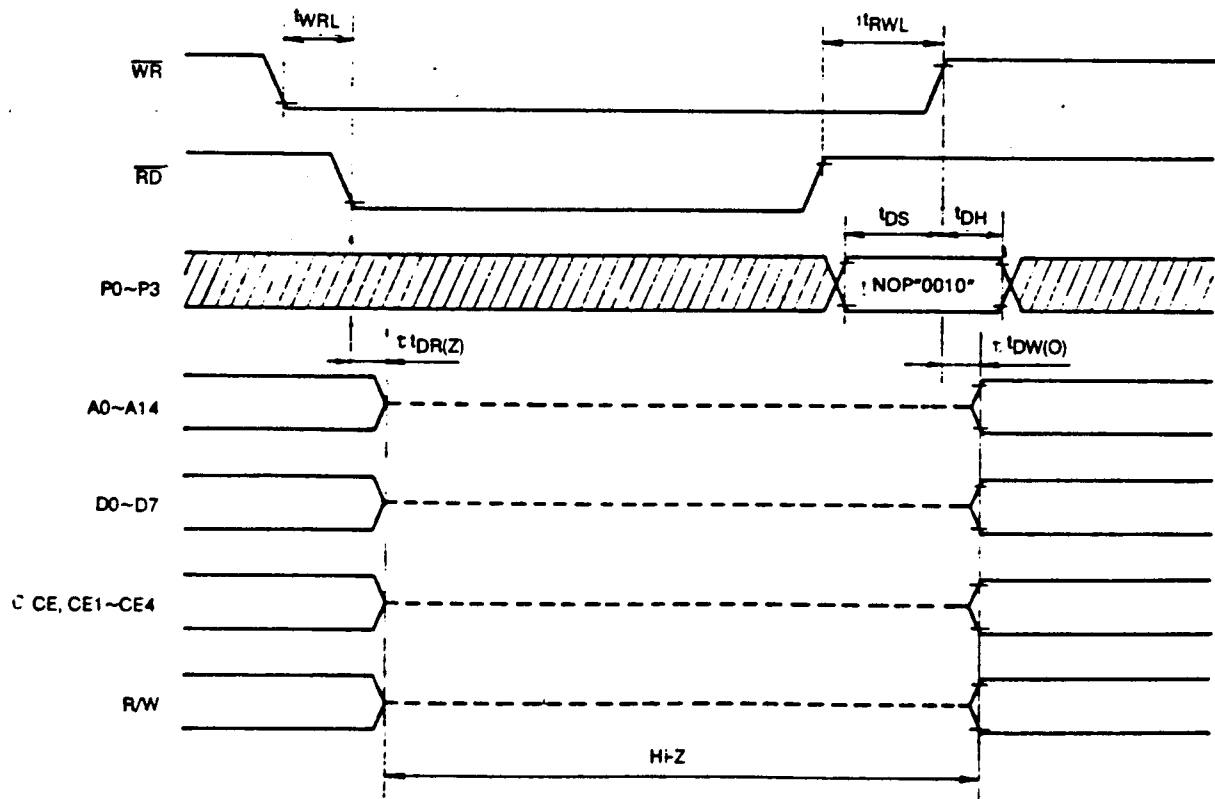

10.4 Characteristics of analog part

(1) Microphone amplifier (Unless otherwise specified, $V_{SS1}=V_{SS2}=0V$, $V_{DD}=5.0V$, $T_a=25^{\circ}C$, $f_{in}=1kHz$)

| ITEM | APPLIED PIN | SYMBOL | TEST CONDITION | STANDARD VALUE | | | UNIT |
|------------------------------|-------------|-----------|--|----------------|------|------|------------|
| | | | | MIN. | TYP. | MAX. | |
| Pass band voltage gain | MICAMP1 | V_{IN1} | $V_{IN}=6mVp-p$ $f_{in}=100Hz \sim 10kHz$ Output load $100k\Omega$ $30pF$ | - | 26 | - | dB |
| | MICAMP2 | V_{IN2} | | - | 20 | - | |
| Total harmonic distortion | MICAMP1 | V_{G1} | $V_{in}=6mVp-p$ | - | 2 | - | % |
| | MICAMP2 | V_{G2} | | - | 2 | - | |
| Max. allowable input voltage | MICAMP1 | V_{IN1} | - | - | - | 200 | mVp-p |
| | MICAMP2 | V_{IN2} | | - | - | 400 | |
| Input impedance | MICAMP1 | R_{IN1} | - | - | 30 | - | k Ω |
| | MICAMP2 | R_{IN2} | | - | 30 | - | |

(2) Band-pass filter (Unless otherwise specified, $V_{SS1}=V_{SS2}=0V$, $V_{DD}=5.0V$, $T_a=25^{\circ}C$, $f_{in}=1kHz$)

| ITEM | SYMBOL | TEST CONDITION | STANDARD VALUE | | | UNIT |
|------------------------------|-----------|--|----------------|------|------|------------|
| | | | MIN. | TYP. | MAX. | |
| Pass band voltage gain | V_G | $V_{IN}=1.0Vp-p$ Output load $100k\Omega$ $30pF$ | - | 0 | - | dB |
| Total harmonic distortion | THD | $V_{IN}=1.0Vp-p$ | - | 4 | - | % |
| Max. allowable input voltage | V_{IN} | | - | 4.0 | - | Vp-p |
| Output impedance | R_{OUT} | | - | 1 | - | k Ω |

(3) ADM analysis synthesizer circuit (Unless otherwise specified, $V_{SS1}=V_{SS2}=0V$, $V_{DD}=5.0V$, $T_a=25^{\circ}C$, $f_{in}=1kHz$)

| ITEM | SYMBOL | TEST CONDITION | STANDARD VALUE | | | UNIT |
|------------------------------|----------|----------------|----------------|------|------|------|
| | | | MIN. | TYP. | MAX. | |
| Max. allowable input voltage | V_{IN} | - | - | - | 3.5 | Vp-p |

[11] EXAMPLE OF APPLICATION CIRCUIT

MANUAL CONTROL

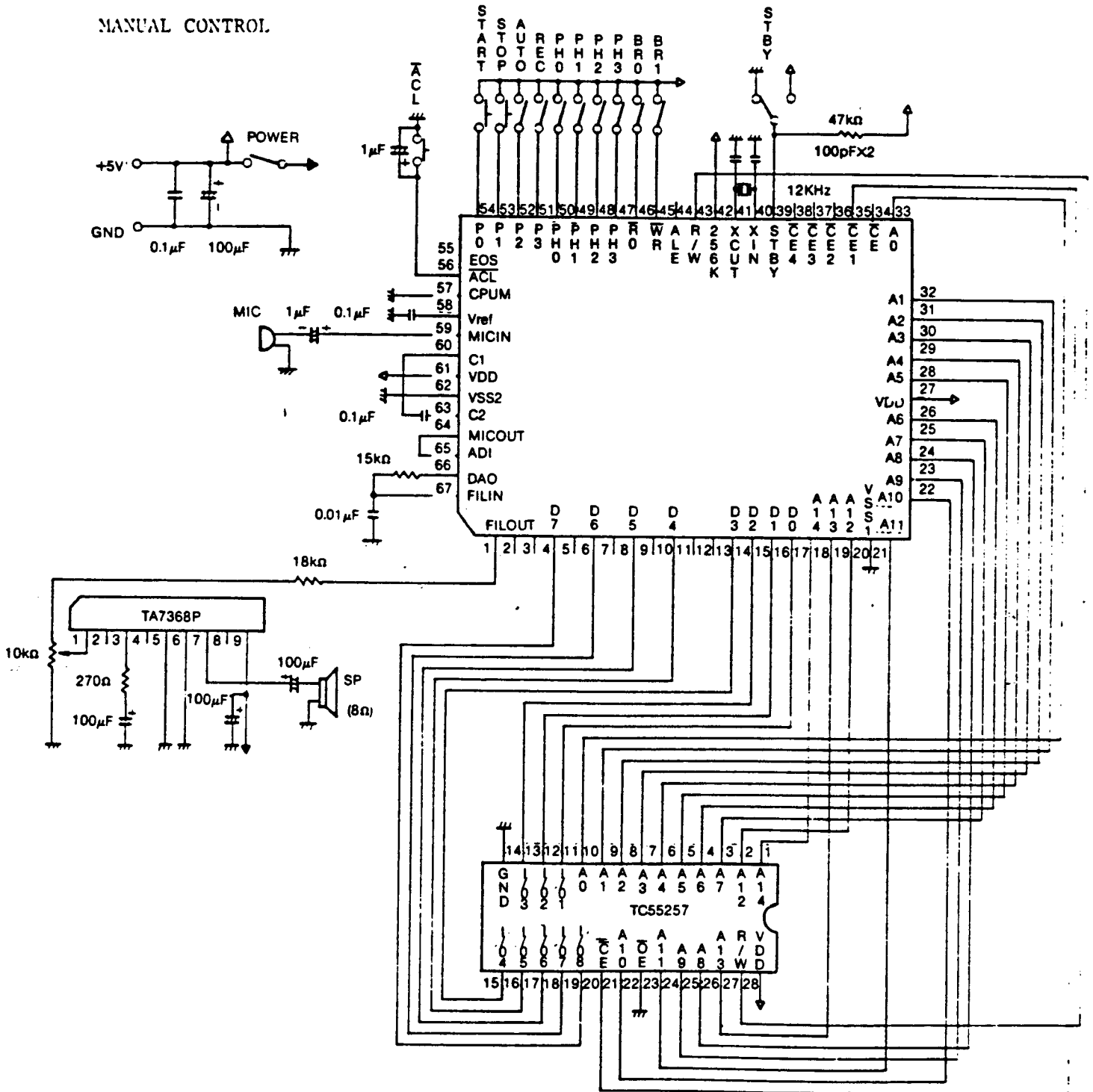

* 0.1µF capacitor must be connected between V_{DD} and GND in S-RAM.

* On TC8830F, pins which are not connected must be opened.